



**UNIVERSITY OF  
CAMBRIDGE**

Department of Engineering

**Institute for Manufacturing**

**METIIA Course  
Handbook 2022-23**

# Disclaimer

We have endeavoured to ensure that the information contained in this handbook is as accurate as possible. However, it is likely that minor changes and updates may need to be made to some sections during the course of the year.

We will ensure that all updates are communicated to you by email and/or posted on the MET IIA Moodle site.

## Contents

MET IIA People	4
Year group	7
IfM Map	8
<b>Course overview &amp; timetables</b>	
Summary of Taught Modules	9
Examinations and Coursework Structure	10
Timetables (Michaelmas, Lent and Easter)	11
Induction	14
Skills workshops and industrial visits	16
<b>Module specifications</b>	
3P1: Materials into Products	24
3P2: Operation and Control of Production Machines and Systems	28
3P3: Product Design	32
3P4: Operations Management	35
3P5: Industrial Engineering	38
3P6: Organisational Behaviour	41
3P7: Managing Business and People	44
3P8: Financial and Management Accounting	48
3P9: Industrial Economics, Strategy and Governance	50
3P10: Contemporary Issues in Manufacturing	52
<b>Coursework specifications</b>	
CAD/CAM Exercise	56
Production Game	58
Major Project	60
<b>General information</b>	
Penalties for Late Hand In of Coursework and Missed Industrial Visits	62
Workshop Practical	63
Overseas Research Project	65
Information and library services	67
<b>Appendix 1: Referencing and Plagiarism</b>	68
<b>Appendix 2: Sample of METIIA Forms</b>	73

# MET Ila People

---

## Course Directors



Prof Chander Velu (IIa)



Prof Frank Tietze (IIb)

---

## Teaching office



Shane Strawson (Senior MET Admin)



Sally King (Senior ISMM Admin)

Hannah Smith  
Teaching Office Admin

---

## 3P1 Materials into Products (Mich)



Dr Hugh Shercliff (module leader)



Dr Claire Barlow

---

## 3P2 Operation and Control of Production Machines and Systems (Mich)



Prof Duncan McFarlane (module leader)



Dr Sebastian Pattinson

---

## 3P3 Product Design (Mich)



Prof James Moultrie (module leader)



Prof Michael De Volder

---

## 3P4 Operations Management (Lent)



Dr Feryal Erhun (module leader)



Dr Tariq Massood

---

## 3P5 Industrial Engineering (Lent)



Dr Veronica Martinez (module leader)

---

---

**3P6  
Organisational  
Behaviour (Mich)**



Dr Mukesh Kumar  
(module leader)

---

**3P7 Managing  
Business and  
People (Lent)**



Prof Tim Minshall  
(module leader)

---

**3P8 Financial  
and  
Management  
Accounting  
(Mich)**



Dr Judith Plummer-  
Braeckman  
(module leader)

---

**3P9 Industrial  
Economics,  
Strategy and  
Governance  
(Lent)**



Dr Florian Urmetzer  
(module leader)

---

**3P10  
Contemporary  
Issues in  
Manufacturing  
(Mich)**



Prof Ronan Daly  
(module leader)



Dr Claire Barlow

---

**Major Project**



Prof James Moutlrie



Prof Michaël De Volder



Dr Sebastian  
Pattinson



Dr Judith Plummer-  
Braeckman

---

**Industrial Visits  
and Workshops**



Dr Letizia Mortara

---

---

**IT Support**



Lewis Grantham (Heads the IT team)



Giles Hainsworth (Senior Computing Technician)

---

**Workshop / Technical support**



Alan Thorne (Technical officer)



Chris Jennings (Workshop technician, mechanical)



Simon Sennitt (Workshop technician, electrical)

---

**Others who you should know**



Maggie Harriss (IfM Divisional Administrator)



Bridget Dore (Catering Supervisor)



Ella Whellams (IfM Engage Events manager & supports the design show)



Lisa Barrett (IfM Engage & supports the design show)

## **2022-23 Year Group**

# IfM Floor Plan

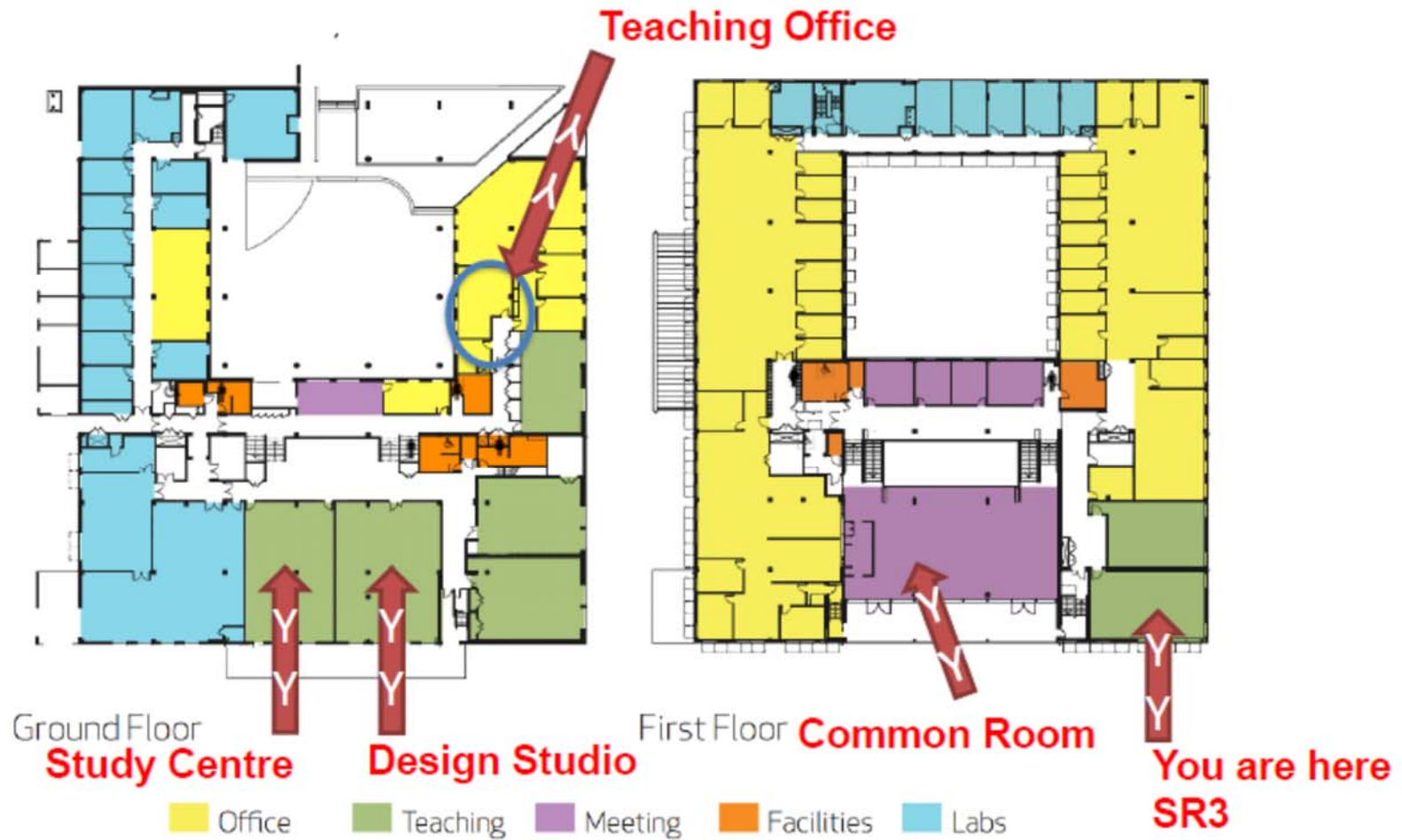



# Course overview and timetables

## Summary of Taught Modules

Module number	Module Title	Module Scope	Assessment	Term
3P1	Materials into Products	From microstructure to mechanical property: manufacturing process optimisation for all classes of solids	100% Examination	Michaelmas
3P2	Production Machines and Systems	The specification, operation and management of production machines and systems	100% Examination	Michaelmas
3P3	Design	Integrating engineering and industrial design in the creation of new products	100% Coursework	Michaelmas
3P4	Operations Management	The management of material and information flow in the supply chain	100% Examination	Lent
3P5	Industrial Engineering	The design of production flows and operations in manufacturing	100% Examination	Lent
3P6	Organisational Behaviour	An introduction to the theory of organisational behaviour	100% Examination	Michaelmas
3P7	Managing Business and People	An introduction to the processes involved in starting and running a business	100% Examination	Lent
3P8	Financial and Management Accounting	An introduction to the principles and practice of financial and management accounting	100% Examination	Michaelmas
3P9	Industrial Economics, Strategy and Governance	An introduction to the principles and practice of industrial economics, strategy and corporate governance	100% Examination	Lent
3P10	Contemporary Issues in Manufacturing	(a) Integrative industrial visits to study modern manufacturing practice (b) Lectures to introduce current topics	100% Examination	Michaelmas

## Examinations and Coursework Structure

Name	Descriptor	Contents	Marks
Paper 1	Single module paper: 90 minutes Common with 3C1	Module 3P1, Materials into Products	60
Paper 2	Single module paper: 90 minutes	Module 3P2, Production Machines and Systems	60
Paper 3	Double module paper: 3 hours	Module 3P4, Operations Management Module 3P5, Industrial Engineering	120
Paper 4	Double module paper: 3 hours	Module 3P6, Organisational Behaviour Module 3P7, Managing Business and People	120
Paper 5	Double module paper: 3 hours	Module 3P8, Financial and Management Accounting Module 3P9, Industrial Economics, Strategy and Governance	120
Paper 6	Single module paper: 90 minutes	Module 3P10, Contemporary Issues in Manufacturing	60
3P3 Product Design	Single module assessed coursework		60
Major Project	Coursework		140
CAD/CAM exercise	Coursework		30
Production Game	Coursework		30
Visits	Coursework		40
<b>TOTAL</b>			<b>840</b>

Michaelmas Timetable: **Note, these timetables are provisional and are subject to change**

**Michaelmas Term 2022**

Term begins on Tuesday 4th October and ends on Friday 2nd December 2022

Paper numbers are shown in bold text, weeks in square brackets if not weeks 1-8 and room numbers in italics.

weeks		9-10	10-11	11-12	12-1	1-2	2-3	3-4	4-5	5-6		
0	03-Oct	<b>Induction [0], VELU/DALY</b>					<b>Induction [0], DALY</b>					
1	10-Oct	<b>3P10: Contemp issues in manuf. [1], BARLOW</b>					Rapid Prototype Workshop 1 (group of 13 students)					
2	17-Oct	<b>3P10: Contemp issues in manuf. [2], BARLOW, DALY</b>					Workshop (1) - (Group of 4 students)					
3	24-Oct	<b>3P6: Organisational Behaviour [1-8], KUMAR</b>				Lunch	Workshop (5) - (Group of 4 students)					
4	31-Oct						Workshop (8) - (Group of 4 students)					
5	07-Nov											
6	14-Nov											
7	21-Nov											
8	28-Nov											
0	04-Oct	<b>Induction [0], DALY</b>					<b>Induction [0], DALY</b>					
1	11-Oct					<b>Industrial Visit: scheduled all day but may finish earlier depending upon location</b>						
2	18-Oct	Visit Debrief				Skills workshop		Workshop (2) - (Group of 4 students)				
3	25-Oct					<b>Industrial Visit: scheduled all day but may finish earlier depending upon location</b>						
4	01-Nov	Visit Debrief				Skills workshop		Workshop (9) - (Group of 4 students)				
5	08-Nov					<b>Industrial Visit: scheduled all day but may finish earlier depending upon location</b>						
6	15-Nov	Visit Debrief				Skills workshop						
7	22-Nov					<b>Industrial Visit: scheduled all day but may finish earlier depending upon location</b>						
8	29-Nov	Visit Debrief				Skills workshop						
0	05-Oct	<b>Induction [0], DALY, I/M</b>										
1	12-Oct	<b>3P1: Materials into products [1-8], BARLOW/DURRELL/SHERCLIFF</b>				<b>3P8: Financial &amp; management accounting, [1-8], BRAECKMAN</b>				Lunch	Rapid Prototype Workshop 2 (group of 13 students)	
2	19-Oct										Workshop (3) - (Group of 4 students)	
3	26-Oct										Workshop (6) - (Group of 4 students)	
4	02-Nov										Workshop (10) - (Group of 4 students)	
5	09-Nov											
6	16-Nov											
7	23-Nov											
8	30-Nov											
1	06-Oct	L1: Process & prototyping (JM)		L2: Machine systems design (MFLD) (Design Task briefing at 12.30)				Design Task Work				
2	13-Oct	Design challenge competition and debrief		L3 Actuators (MLFD)		L4 Tolerances (JM)		<b>Introduction to Solidworks, THORNE</b>				
3	20-Oct	L5 Bearings (MLFD)		L6 Mechanisms (MLFD)		Coursework Briefing		<b>SOLID CAM: Milling, Briefing of CAD/CAM coursework, THORNE</b>				
4	27-Oct	L7 Design for Assembly (JM)		DfA Exercise				<b>SOLID CAM: Turning, THORNE</b>				
5	03-Nov	L8 Design for Manufacture (MFLD)		L9 Design for Injection Moulding (MFLD)		L10 Design for AM (JM)		L11: Ergonomics (JM)		Optional: Sketching workshop		
6	10-Nov	L12 Design History JM		L13 Finding Form (JM)		Coursework Q&A				Optional: Design Portfolio workshop		
7	17-Nov	Major Project Briefing		Major Project Work						Major Project Work / Coursework		
8	24-Nov	Project announcements/notices. 9:20 onwards Project consultations (sign up sheet available at 9am)										
9	01-Dec	Major Project Proposal Presentations SR3										
1	07-Oct	<b>3P1: Materials into products [1-8], BARLOW/DURRELL/SHERCLIFF</b>				<b>3P2: Production machines &amp; systems [1-4], PATTINSON, [5-8], MCFARLANE</b>				Lunch	<b>3P10: Contemp issues in manuf. [1], BARLOW</b>	
2	14-Oct										Rapid Prototype Workshop 3 (group of 13 students)	
3	21-Oct										Workshop (4) - (Group of 4 students)	
4	28-Oct										Workshop (7) - (Group of 4 students)	
5	04-Nov											
6	11-Nov											
7	18-Nov											
8	25-Nov											
9	02-Dec											

Lent timetable: **Note, these timetables are provisional and are subject to change**

**Lent Term 2023**

Term begins on Tuesday 17 January and ends on Friday 17 March 2023

Paper numbers are shown in bold text, weeks in square brackets if not weeks 1-8 and room numbers in italics.

weeks		9-10	10-11	11-12	12-1	1-2	2-3	3-4	4-5	5-6
0	16-Jan									
1	23-Jan									
2	30-Jan									
3	06-Feb									
4	13-Feb			<b>3P5: Industrial Engineering [1-8], MARTINEZ</b>		<i>Lunch</i>				
5	20-Feb									
6	27-Feb									
7	06-Mar									
8	13-Mar									
0	17-Jan									
1	24-Jan									
2	31-Jan			<b>Industrial Visit: scheduled all day but may finish earlier depending upon location</b>						
3	07-Feb	<b>Visit Debrief</b>		<b>Skills workshop</b>						
4	14-Feb			<b>Industrial Visit: scheduled all day but may finish earlier depending upon location</b>						
5	21-Feb	<b>Visit Debrief</b>		<b>Skills workshop</b>						
6	28-Feb			<b>Industrial Visit: scheduled all day but may finish earlier depending upon location</b>						
7	07-Mar	<b>Visit Debrief</b>		<b>Skills workshop</b>						
8	14-Mar			<b>Visit Final Presentations - all day</b>						
0	18-Jan									
1	25-Jan									
2	01-Feb									
3	08-Feb									
4	15-Feb	<b>3P9: Industrial Economics [1-8], URMETZER</b>		<b>3P4: Operations Management, [1-8] ERHUN/MASOOD</b>		<i>Lunch</i>				
5	22-Feb									
6	01-Mar									
7	08-Mar									
8	15-Mar									
1	19-Jan	<b>Major Project: Project group consultations</b>						<b>Major Project: Group Work</b>		
2	26-Jan	<b>Major Project: Supervisions</b>						<b>Major Project: Group Work</b>		
3	02-Feb	<b>Major Project: Design review 1</b>						<b>Major Project: Group Work</b>		
4	09-Feb	<b>Major Project: Project group consultations (introduction to financials spreadsheet &amp; unit costs)</b>					<i>Lunch</i>	<b>Major Project: Group Work</b>		
5	16-Feb	<b>Major Project: Project group consultations</b>						<b>Major Project: Group Work</b>		
6	23-Feb	<b>Major Project: Design review 2</b>						<b>Major Project: Group Work</b>		
7	02-Mar	<b>Major Project: Business Plan briefing</b>						<b>Major Project: Group Work</b>		
8	09-Mar									
9	16-Mar									
1	20-Jan									
2	27-Jan									
3	03-Feb									
4	10-Feb	<b>3P7: Managing Business and People [1-8], MINSHALL</b>				<i>Lunch</i>				
5	17-Feb									
6	24-Feb									
7	03-Mar									
8	10-Mar									
9	17-Mar					<i>Lunch</i>	<b>Production Game [7] (commencing at 1pm)</b>			

Easter timetable: **Note, these timetables are provisional and are subject to change**

**Easter Term 2023**

Term begins on Tuesday 25 April and ends on Friday 16 June 2023

weeks		9-10	10-11	11-12	12-1	1-2	2-3	3-4	4-5	5-6									
0	24-Apr	<i>Exam period</i>																	
1	01-May	<i>Exam period</i>																	
2	08-May	<i>Major Project Period</i>																	
3	15-May																		
4	22-May																		
5	29-May																		
6	05-Jun																		
7	12-Jun	<b>Major Project: Hand in portfolio, Business plan, Web-site</b>																	
8	19-Jun																		
0	25-Apr	<i>Exam period</i>																	
1	02-May	<i>Exam period</i>																	
2	09-May	<i>Major Project period</i>																	
3	16-May																		
4	23-May																		
5	30-May																		
6	06-Jun																		
7	13-Jun																		
8	20-Jun																		
0	26-Apr	<i>Exam period</i>																	
1	03-May	<i>Exam period</i>																	
2	10-May	<i>Major Project period</i>																	
3	17-May																		
4	24-May																		
5	31-May																		
6	07-Jun																		
7	14-Jun	<b>MAJOR PROJECT FINAL PRESENTATIONS (Poster Display and evening reception)</b>																	
8	21-Jun																		
1	27-Apr	<i>Exam period</i>																	
2	04-May	<i>Exam period</i>																	
3	11-May	<i>Major Project period</i>																	
4	18-May										Supervisions: Team 1, 2, 3	Supervisions: Team 4, 5, 6	11.30 - 12.30 Supervisions: Team 7, 8, 9, 10						
5	25-May																		
6	01-Jun																		
7	08-Jun																		
8	15-Jun																		
9	22-Jun																		
1	28-Apr	<i>Exam period</i>																	
2	05-May	<i>Exam period</i>																	
3	12-May	<i>Major Project Period</i>																	
4	19-May																		
5	26-May																		
6	02-Jun																		
7	09-Jun																		
8	16-Jun																		

# Induction

## *Aims*

- ***To provide information about the course*** including: the content and structure of the taught modules; the opportunity presented by the course work to demonstrate an integrative approach; the process and administration of the 3P10 Company Visits; tablet based teaching; the methods of examination; timetable and locations.
- ***To ensure operating procedures and administration are understood***: including the different ethos from Part 1 of Engineering; the role of the IfM teaching office; the use of Moodle for providing information and taught content; access to admin and teaching staff; layout of the Alan Reece Building and the use of its facilities.
- ***To start the skills development programme***. The induction programme includes sessions on communications, including presentation skills which are required early in the course. The remainder of the skills development programme takes place on alternate Tuesdays during Michaelmas and Lent terms.
- ***To facilitate group bonding*** which is essential for the successful operation of the course. Students will meet academic and teaching staff, and the style of the course will be interactive with taught inputs interspersed with small group activities.
- ***To provide a brief introduction to Manufacturing*** to emphasise the integrated nature of Manufacturing and to explain the importance of retaining this perspective even though the subject is deconstructed into modules for the purposes of teaching.

## **Teaching style**

To meet these aims the induction programme will necessarily contain some taught input but will include substantial periods of interactive learning through group work and exercises.

## **Location**

The induction programme is based in the Alan Reece Building, Seminar Room 3. Some components, highlighted in the timetable will be delivered remotely and additional resources will be available online.

## Induction programme

<b>Mon 3 October</b>		
	Introductions	
10:00 – 10:45	Welcome from Professor Tim Minshall Welcome and overview of induction programme Discussion: your hopes from MET	Tim Minshall Chander Velu
10:45 – 11:15	Course overview and administration	Chander Velu
11:15 – 11:30	<i>Break</i>	
11:30 – 12:30	Manufacturing awareness	Ronan Daly / Sebastian Pattinson
<b>12:30 – 14:00</b>	<b>Buffet lunch with ISMM, MET and Staff</b>	<b>ALL</b>
14:00 – 14:45	Company visits: aims, visits process, themes and topics, assessment, safety	Letizia Mortara
14:45 – 15:00	IfM Health and Safety	Sebastian Pattinson
15:00 – 15:30	Introduction to workshop training	Alan Thorne
15:30 – 16:15	Workshop Health and Safety lecture	Alan Thorne / Simon Sennitt / Chris Jennings
16:15 – 16:45	Facilities tours	Simon Sennitt / Chris Jennings
<b>Tues 4 October</b>		
09:00 – 09:30	Careers talk	Raj Sidhu
09:30 – 10:00	Introduction Library Facilities	Emma Etteridge/ Andrew Alexander
10:00 – 11:00	Retail shop exercise: Briefing	Chander Velu
11:00 – 14:00	Retail shop exercise: Store Observation and Presentation Preparation Lunch: Own arrangements	Chander Velu
14:00-16:00	Retail shop exercise: Group Presentation and Feedback	Chander Velu
<b>Wed 5 October</b>		
0900 – 10:30	Presentation Methods	Chander Velu
10:30 – 10:45	<i>Break</i>	
10:45 – 11:30	Presentation Preparation	Chander Velu
11:30 – 12:30	Group Presentation and Lessons Learnt	Chander Velu

# Industrial Visits and Skills Workshops

Programme Leader: Dr Letizia Mortara

## Programme

The Module consists of Industrial Visits and skills development workshops. These are delivered during the Michaelmas and Lent terms to allow maximum opportunity for observing real manufacturing environment and for testing and practicing a variety of managerial and practical skills as the course progresses.

Industrial visits occur on Tuesdays, and typically are organised every other week (see programme)<sup>1</sup>. In the intervening week, on the Tuesdays the programme comprises debriefing sessions and skills workshops. The workshops start in the Induction programme and thereafter during all Michaelmas and Lent terms.

All the elements of this module require attendance – absences are penalised according to the criteria.

## Industrial visits: Briefing and Debriefing

Each visit day addresses a different business sector. All students therefore make all the visits, one for each business sector.

Each visit group is divided into teams, with each team focusing on a different generic theme during the visit. The themes will be rotated between the teams so that each team focuses on a different theme for each visit (see example of table below). For every visit, one team will be responsible for collating the input from all the teams in their group to make the debriefing presentation. This responsibility will also be rotated between the teams.

The programme is assessed and so attendance is expected at all events. Any absence from any industrial visits needs to be approved by your College Tutor, the Module Leader and the IfM Teaching Office through the available request forms. Unapproved absences will result in penalties being applied to the overall module mark.

The following approach is suggested:

- i. Teams collect information on their theme during the visit.
- ii. Teams structure their information and feed to the presenter team. This should be started on the return coach trip while the details are still fresh. Summary power point slides should be given to the presenter team by the Thursday following the visit.
- iii. The presenter team prepares a 30 minute power point presentation incorporating information from all the teams. The presentation should be structured and edited to ensure an integrated overview of the company.
- iv. The formal debrief normally takes place on the Tuesday following the visit. All members of the team whose debrief is due need to attend and present. At these

---

<sup>1</sup> The programme might be changed during the year – for the most up-to-date version lookup the industrial Visits Moodle folder



- de-briefing sessions, students from both visit groups come together, with their visit supervisors and the visits programme Module Leader.
- v. The debriefing presentations are evaluated by the Module Leader and the accompanying supervisors (15/40 marks). The debriefing presentations are evaluated as a group (all students will receive the same mark).
  - vi. Debriefing process: The first visit group make their presentation, followed by discussion and questions, principally from the other group. All members of the first group will be encouraged to participate in the discussion. The process is repeated for the second visit group. There is a round up discussion about each of the themes in turn, drawing out comparisons and differences between the companies.
  - vii. The presenters' team annotates their power point slides with comments head of the presentation and update them as a result of the discussion. The annotated slides need to be sent to the teaching office after the presentations and are made available to all students on Moodle for reference and revision in preparation of the final review presentation.
  - viii. At the end of the year, a review of the visits will constitute the rest of the module marks (25/40). The process is as follows:
    - a. Students are allocated to each generic theme groups
    - b. Within each group, discussions to review material from all visits will take place to identify learnings across all the cases visited during the previous months. A final presentation will be prepared with annotated slides
    - c. On the final presentation day, each group will have 20 minutes (exactly) to present (each member of each team will need to contribute and present) and will receive questions from the module leader and the assessors as well as from the rest of the class. The overall final presentation day will last approximately 4 hours.
    - d. After the presentation, presenters update their slides to record the discussion and send their work to the Teaching office.

## Visits

Companies will be informed of those attending. **It is important that the students' calendar remains completely free on Tuesdays for the whole day, to facilitate our organisation of visits.** As the Covid pandemic is still morphing, changes to the calendar can happen at any point during the programme.

Punctuality is expected. The coaches will be leaving on time and will not wait for any late student. Any absence needs to be communicated. Please check the MET Allowance rules and procedures. Please inform the IfM Teaching office ([met-admin@eng.cam.ac.uk](mailto:met-admin@eng.cam.ac.uk)) for consideration.

## Expenses







If you will be out of Cambridge over lunchtime, then either the company will provide lunch, or MET will make a contribution towards the cost of meal purchased. In this case, students will be told explicitly that they may claim for lunch on that day. The maximum amount which may be claimed for lunch is £3.00. This is reckoned on the basis of the difference between the cost of a College meal and the cost of a meal on the open market; it is not expected to cover the

full cost of a meal. Claims should be made on expenses forms which are available from the MET Course Admin Moodle page. Expenses can only be claimed against receipts.

### Dress Code

When visiting companies you are representing Cambridge University and the Institute for Manufacturing, and you are expected to maintain the high standards for which we are known. You should always behave in a responsible and professional manner, and you should be smartly turned-out and appropriately dressed. This means in compliance with the requests of the companies (which will be listed on the briefing provided ahead of each visit). You should always wear sensible shoes and **not** trainers on factory visits (no high heels or sandals). On some occasions safety footwear will be required, this will be advised on the Visit Brief. Other requirements, including the use of photography, may be specified by the company and must be adhered to.

### Company visits schematic (example)

 De-briefing presenting responsibility * Responsibility for taking notes during industrial visits and contributing to de-briefing team  Group 1      Group 2		De-briefing presentations					Final presentation
		Sector 1 Primary Processes	Sector 2 Electro-mechanical	Sector 3 Food	Sector 4 Vehicles	Sector 5 Goods and information distribution	Review of practices Across sectors
		Team 1A	Team 2A	*Materials Prod process	*Ops Mgt	*Industrial Eng	 *Design Mgt
Team 1B	Team 2B	*Ops Mgt	*Industrial Eng	 *Design Mgt	*HR+CSR	*Materials Prod process	Design Mgt
Team 1C	Team 2C	*Industrial Eng	 *Design Mgt	*HR+CSR	*Materials Prod process	*Ops Mgt	HR +CSR
Team 1D	Team 2D	 *Design Mgt	*HR+CSR	*Materials Prod process	*Ops Mgt	*Industrial Eng	Materials Prod process
Team 1E	Team 2E	*HR+ CSR	*Materials Prod process	*Ops mgt	*Industrial Eng	 *Design Mgt	Ops mgt

## Visit themes

Theme	Details
Industry level context	<ul style="list-style-type: none"> <li>• <i>History</i> - how has the industry developed: what technical and structural changes have occurred.</li> <li>• <i>Markets</i> - where are the major markets – how is this forecast to change; what are the current market conditions; what are the major trends affecting the industry.</li> <li>• <i>Competition</i> - who are the major players; what market shares.</li> </ul>
Company level context	<ul style="list-style-type: none"> <li>• <i>History</i> – what is the history of the company; has the ownership structure changed; is there a specific culture, ethos, or set of values.</li> <li>• <i>Scale</i> - key metrics for this site – turnover, employees, products</li> <li>• <i>Structure</i> – how is the company structured; how does it fit into the whole organisation.</li> <li>• <i>Market</i> - where does the company position itself in the market; who is the competition; who are the customers; where are they.</li> <li>• <i>Products</i> - what is the range of products - to what extent are products customised</li> <li>• <i>Strategy</i> - what is the business model – how does the company make money; how does the company compete – price, quality delivery, responsiveness, others; what is the impact of low cost economies.</li> </ul>
Materials, production processes and technology	<ul style="list-style-type: none"> <li>• <i>Materials</i> - what range of materials is used – why; where are they sourced.</li> <li>• <i>Production processes</i> - what production processes are employed; are there any areas of special expertise; which processes are outsourced – why and where to; what level of automation is in evidence – are there further opportunities; is the operation labour intensive or capital intensive.</li> <li>• <i>Technology</i> - how does the company stay abreast of technical developments; how is new equipment selected and justified.</li> </ul>
Operations Mgt - organisation and control	<ul style="list-style-type: none"> <li>• How many product variants are there – how does uncertainty affect the business and manufacturing operations</li> <li>• What are the key challenges in matching supply and demand</li> <li>• What is the typical time from order to delivery.</li> <li>• How is production configured - cell, line, functional etc – why.</li> <li>• What cost reduction techniques are used.</li> <li>• How are lean processes applied.</li> <li>• What are the systems for controlling production flow e.g. MRP, JIT, Kanban etc</li> </ul>
Industrial engineering and quality	<ul style="list-style-type: none"> <li>• <i>Industrial engineering</i> - how are work study methods applied; how is work place layout determined; how are task times determined; what performance measures are used.</li> <li>• <i>Quality</i> - what quality control systems are in place; are statistical approaches in evidence; what continuous improvement techniques are used e.g. quality circles, kaizan projects, suggestion schemes</li> </ul>

Design management	<ul style="list-style-type: none"> <li>• How is the brand positioned in the market?</li> <li>• What is the customer journey: what are the range of 'touch points' (e.g. web, brochures, people, stores, telephone calls etc.) that define the customers interface with the company. How are these designed and who is responsible for ensuring consistency?</li> <li>• What is the company's design strategy?</li> <li>• How are industrial and engineering design linked?</li> </ul>
Human Resources + Corporate social responsibility, H&S, environment and sustainability	<ul style="list-style-type: none"> <li>• <i>Recruitment and training</i> - how are employees recruited and trained; what are the critical skills; how are they developed; how are they forecast to change.</li> <li>• <i>Remuneration</i> - what pay systems are in place – e.g. piece work, salary, bonus; what non pay reward systems are in place.</li> <li>• <i>Employee relations</i> - are any unions recognised; what structures are in place to work with them; how are communications with employees handled.</li> <li>• <i>H&amp;S</i> – what is the company's safety record; how is safety managed.</li> <li>• <i>Environment</i> - why is the operation based in this locality – what advantages, disadvantages; what is the impact of the operation on the local environment and community; what measures are in place to reduce any negative impact; in what ways does the company engage with the community.</li> <li>• <i>Sustainability</i> - what regulations impinge on the business – are they getting tougher; are alternative technologies being developed to reduce the environmental impact – are there cost implications; how are sustainability issues affecting the business – markets, products, operations.</li> </ul>

## Skills workshops<sup>2</sup>

The skills workshops are designed to develop some of the personal skills critical for success in industry and related employment. The skills are introduced in the workshop series and are practiced and developed during the two years of the MET programme.

The skills considered in the workshop series are<sup>2</sup>:

- **Process improvement skills:** bringing improvements to manufacturing processes form a fundamental part of the skillset that any manufacturing engineer must possess. These sessions focus on using structured approaches to understand a manufacturing process and to improve its performance.
- **Working in Teams:** this session focuses on understanding and identifying the different skills, personalities and motivations which individuals bring to a team, and the ways in which they can be harnessed to optimum effect.
- **Writing skills:** these are essential both in exams and detailed reports that require you to present a broad set of ideas in a coherent, evidence-based structure. A workshop and discussion will develop the skills, which will be of use throughout your career.
- **Artefacts workshop:** exploring how different components are manufactured.
- **Examination skills:** giving guidance on examinations and examination preparation skills.

<sup>2</sup> The skills workshops list will be updated at the start of the year. Please refer to Moodle more up to date timetable.

**NOTE: Please check email and MOODLE for updated schedule.**

**All debrief and workshop sessions will be held at the IfM, Alan Reece Building, SR3**

**Example timetable (this is indicative, the visits and de-briefing days can change. See Moodle for up to date schedule)**

<b>Michaelmas</b>	<b>Morning</b>	<b>Afternoon</b>
<b>3 October (Mon)</b>	Introduction	
<b>11 October (Tue)</b>	Visits	
<b>18 October (Tue)</b>	Debriefing and Skills workshop	
<b>25 October (Tue)</b>	Visits	
<b>1 November (Tue)</b>	Debriefing and Skills workshop	
<b>8 November</b>	Visits	
<b>15 November</b>	Debriefing and Skills workshop	
<b>22 November</b>	Visits	
<b>29 November</b>	Debriefing and Skills workshop	
<b>Lent</b>		
<b>24 January (Tue)</b>		
<b>31 January (Tue)</b>	Visits	
<b>7 February (Tue)</b>	Debriefing and Skills workshop	
<b>14 February</b>	Visits	
<b>21 February</b>	Debriefing and Skills workshop	
<b>28 February</b>	Visits	
<b>7 March</b>	Debriefing and Skills workshop	
<b>14 March</b>	Final Presentations	

## Marking scheme

The programme is assessed and a total of 40 marks are available (15 marks for the sector analysis presentations and 25 for the final presentation). Presentations are evaluated as a group (all students in the team will receive the same marks).

Attendance is expected at all events. Any absence from any assessed part (i.e. sector analyses presentations and final year presentation) and from the industrial in person visits, needs to be approved by your College Tutor, the Module Leader and the IfM Teaching Office through the available request forms. Unjustified absences will incur in marks penalty.

### Penalties for unjustified absences:

<b>Absences</b>	<b>Penalty</b>
Any in person industrial visit	3 marks
Your sector analysis presentation	15 marks
Your final year presentation	15 marks

# Module Specifications

**Note: PART IIA BOOKLIST**

The Library Shelfmark indicates where these works can be found in the Library.

An additional copy of books marked with a star (\*) will be available in a Special Part II Reference Collection kept in the Library; the attention of Directors of Studies (for College Librarians) will be drawn to these titles.

## 3P1: Materials into products

<b>Module summary</b>	From microstructure to final properties: manufacturing process optimisation for all classes of materials.
<b>Taught by</b>	Dr H Shercliff (module leader) Dr C Barlow,
<b>Supporting activities</b>	Artefacts workshops - TBA
<b>Assessment</b>	100% by examination. Paper 1, single module paper common with Engineering Part IIA 3C1
<b>Supervision</b>	3 classes in Michaelmas (one per examples paper) and 1 Tripos class in Lent Typically weeks Michaelmas weeks 3-4, 5-6 and 8, and Lent week 1
<b>Links to other elements of the course</b>	Complementary materials know-how for aspects of 3P2 (processes), 3P3 (design) and Major Projects. Directly relevant to visits to industrial materials processing operations.

### Module Learning Outcomes

By the end of the course, students should:

- Have a broad appreciation of the different materials processing methods used for metals, ceramics and polymers.
- Understand the main interactions between process and material in design and process selection, for each of the main classes of material.
- Understand the factors which control the microstructure of shaped castings, and their consequences for final properties and design of castings.
- Know the main deformation processes for wrought alloys, and be able to conduct simple upper bound analysis of plastic deformation.
- Know the microstructural characteristics of wrought alloys, and the reasons for alloying and heat treatment, with examples from Al alloys and steels.
- Understand hardenability of steels, using CCT diagrams to select steels and heat treatments for a given component specification.
- Know the main classes of polymers and composites, and understand the processing and design considerations in selecting these for a given component.
- Understand the processes and issues in the manufacture of powder metallurgy and ceramic products, and in additive manufacturing.
- Understand the importance of surface treatments and joining technologies, and know the main factors to consider in process selection.
- Be able to apply their knowledge of materials processing, microstructure evolution, and the mechanisms of material degradation to analyse and predict failures and to improve product design.



## Syllabus

Lecture	Syllabus	On completion students should be able to....
1 Introduction and Process Selection	Classification of manufacturing processes. Coupled problems in design and manufacturing: the interaction between material, process and design parameters.	Take a structured approach to choosing and interpreting viable material-process combinations for making components.
2 Heat Treatment of Steels	Revision of phase transformations and TTT diagrams. CCT diagrams and hardenability for steels.	Predict microstructure and mechanical properties in steel components following a given heat treatment.
3 – 4 Casting of Metals	Ingot and shaped casting. Revision of phase diagrams and transformations applied to solidification: segregation, constitutional supercooling, casting alloys and microstructures. Casting defects and design of shaped castings. <i>Examples paper 1</i>	Describe the factors involved in optimising casting processes, alloys and design to achieve required quality and mechanical properties for a component.
5 – 8 Deformation Processing of Wrought Alloys, Heat treatment.	Wrought alloy processing and microstructure evolution. Simple modelling of plastic forming processes (upper bound method). Application to rolling, forging, extrusion, machining of metals. <i>Examples paper 2</i>	Describe the factors involved in optimising wrought processes, alloys and design to achieve required physical and mechanical properties for a component. Estimate load, power, and temperature rise for shaping processes involving plastic deformation of metals.
9 – 10 Processing of Polymers and Composites	Polymer and composite processing technology.  Design, material and process selection for polymers and composites.	Select polymer and process to achieve required shape and properties for a component. Select manufacturing process to achieve required shape and mechanical properties in fibre-reinforced polymer composites.
11 – 13 Powder Processing, Welding and Joining, Surface Engineering	Sintering, HIPing and other powder methods for metals and ceramics. Additive manufacturing. Welding technologies and other joining processes, and design considerations. Surface engineering processes and their applications.	Describe the factors that govern the choice of powder and additive manufacturing routes instead of conventional processes. Make recommendations for suitability of joining technologies for different materials and applications. Select surface treatments to achieve required physical and mechanical properties.

14 - 16	Processing as the origin of defects and failures (microstructure, damage, residual stress). Environmental factors in failure of materials. Analysis and case studies of failures. <i>Examples paper 3</i>	Identify likely sources of failure for components made from all classes of materials. Propose ways in which such failures can be avoided.
---------	--	--

## Reading List

*ASHBY, M.F.	MATERIALS SELECTION IN MECHANICAL DESIGN Butterworth-Heinemann 4th edition 2010, 3rd edition available as an ebook at: <a href="http://www.myilibrary.com?id=75447">http://www.myilibrary.com?id=75447</a>	JA.208
*ASHBY, M.F. & JONES, D.R.H.	ENGINEERING MATERIALS 2 Butterworth-Heinemann 3rd edition 2006 (mainly revision) Available as an ebook at: <a href="http://www.myilibrary.com?id=75451">http://www.myilibrary.com?id=75451</a>	JA 191
ASHBY, M., SHERCLIFF, H. & CEBON, D.	MATERIALS: ENGINEERING, SCIENCE, PROCESSING AND DESIGN Butterworth-Heinemann 4 <sup>th</sup> edition 2019, 3 <sup>rd</sup> edition 2014, 2nd edition 2010 2nd edition available as an ebook at: <a href="https://www.dawsonera.com/guard/protected/dawson.jsp?name=https://shib.raven.cam.ac.uk/shibboleth&amp;dest=http://www.dawsonera.com/depp/reader/protected/external/AbstractView/S9780080961552">https://www.dawsonera.com/guard/protected/dawson.jsp?name=https://shib.raven.cam.ac.uk/shibboleth&amp;dest=http://www.dawsonera.com/depp/reader/protected/external/AbstractView/S9780080961552</a>	JA.209
CALLADINE, C.R.	PLASTICITY FOR ENGINEERS Ellis Horwood 1985	FA 127
*CAMPBELL, J.	CASTINGS Butterworth-Heinemann 1991 = Author's Castings principles, 2nd ed available as an ebook at: <a href="https://www.dawsonera.com/guard/protected/dawson.jsp?name=https://shib.raven.cam.ac.uk/shibboleth&amp;dest=http://www.dawsonera.com/depp/reader/protected/external/AbstractView/S9780080488448">https://www.dawsonera.com/guard/protected/dawson.jsp?name=https://shib.raven.cam.ac.uk/shibboleth&amp;dest=http://www.dawsonera.com/depp/reader/protected/external/AbstractView/S9780080488448</a>	JO 41
*EDWARDS, L. & ENDEAN, M.	MANUFACTURING WITH MATERIALS Open University 1990	JA 146
JONES, D.R.H.	ENGINEERING MATERIALS III Pergamon 1993	JJ 308
*KALPAKJIA N, S. & SCHMID, S.R.	MANUFACTURING PROCESSES FOR ENGINEERING MATERIALS Pearson/Prentice Hall 5th edition SI units 2008	JN 67
LLEWELLYN, D.T. & HUDD, R.C.	STEELS: METALLURGY & APPLICATIONS Butterworth-Heinemann 3rd edition 1998	JD 64

MILLS, N.J.	PLASTICS Butterworth Heinemann 3rd edition 2005 Available as e-book at <a href="http://www.mylibrary.com/?id=101358">http://www.mylibrary.com/?id=101358</a>	JG 216
*POLMEAR, I.	LIGHT ALLOYS Butterworth-Heinemann 4th edition 2006 Available as an ebook at: <a href="https://www.dawsonera.com/guard/protected/dawson.jsp?name=https://shib.raven.cam.ac.uk/shibboleth&amp;dest=http://www.dawsonera.com/depp/reader/protected/external/AbstractView/S9780080496108">https://www.dawsonera.com/guard/protected/dawson.jsp?name=https://shib.raven.cam.ac.uk/shibboleth&amp;dest=http://www.dawsonera.com/depp/reader/protected/external/AbstractView/S9780080496108</a>	JB 73
ROWE, G.W.	ELEMENTS OF METAL WORKING THEORY Arnold 1979	JN 39
STRONG, A.B.	PLASTICS – MATERIALS AND PROCESSING Pearson Prentice Hall 3rd edition 2006	JG 219
TEMPELMA N, E., SHERCLIFF H.R. & NINABER VAN EYBEN, B.	MANUFACTURING AND DESIGN Butterworth-Heinemann 1 <sup>st</sup> edition 2014	AP343
WATERS, T.F.	FUNDAMENTALS OF MANUFACTURING FOR ENGINEERS UCL Press 1996	BN 204

## 3P2: Operation and Control of Production Machines and Systems

<b>Module summary</b>	The specification, operation and management of production machines and systems
<b>Course leader</b>	Prof Duncan McFarlane
<b>Courses</b>	a. Operation of production machines, 4 x 2hr lectures, Michaelmas Term (Dr S Pattinson) b. Control of production machines and systems, 4 x 2hr lectures, Michaelmas Term (Prof D McFarlane)
<b>Supporting activities</b>	Integrated coursework – CAD/CAM exercise
<b>Assessment</b>	100% by examination. Paper 2 - single module paper.
<b>Supervision</b>	The course will be supported by two examples papers, for each of which one supervision will be arranged.
<b>Timetable</b>	Lectures are given in 2 hour blocks on Fridays (some changes may occur due to time-table issues) in Michaelmas term
<b>Links to other elements of the course</b>	Links to 3P1, 3P4, 3P5, and industrial visits.

### Module Learning Outcomes

On completion of the module students should be able to:

1. Know the operational aspects of the main categories of machining processes
2. Know the operational aspects of the main categories of metal based additive manufacturing processes
3. Understand the types of interaction between components and process tooling
4. Understand the factors that affect the accuracy and precision of machining, grinding operations, and additive manufacturing processes
5. Understand the various control strategies used to mitigate the sources of error in machining processes and the manner in such which machines are automated
6. Understand the systems, requirements and challenges in cell-level automation and
7. Be able to model cell operations using Petri Nets and Ladder Logic
8. Know the means by which machining cells are integrated into factory wide operations using modern communications and computing systems
9. Develop an appreciation for recent developments in industrial automation

## Syllabus: Operation of Production Machines

Lecture	Syllabus	On completion students should be able to ...
1 Introduction to machine tools	History and development of machine tools, and metal based additive manufacturing systems. Concept and definition of machining and machine tools. Classification and specification of machine tools. Basic constructional features, advanced system designs.	Know the history of machine tool developments. Know elements of machine tool design and their configurations. Know their manufacturing and operational capabilities. Know the applications domain and range of materials processed by modern machine tools.
2 Basics of machining and chip formation	Tool geometry, mechanism of chip formation, mechanics of machining, cutting temperature: causes, effects, estimation, measurement and control. Operations of single and multi-point tooling. Classification of machining processes. Basic machining operations - turning, shaping, planing, drilling, milling processes	Understand the basic physics of cutting-tool/material interactions. Understand the influence that parametric variables have on cutting performance (tool tip condition, cutting fluid flow, temperature, force, feed etc). Know the range of cutting tool materials and cutting tip geometries. Know the range of machining methodologies employed in modern machining operations.
3 Cutting tools and machinability	Failure modes, wear mechanisms, and life of cutting tools. Cutting tool materials, influence of geometrical, process and cutting fluid parameters on machinability and surface roughness, economics of cutting tool operations	Know the conditions necessary to deliver accurate machining processes. Understand the causes of wear and process strategies to reduce it. Know the techniques applied to characterize machining performance. Understand roughness classifications and measurement techniques. Understand Taylor's tool life equation and be able to apply it to make informed decisions on tool choice for a range of materials. Determine cost and times of machining operations.
4 Metal Additive Manufacturing Processes (AM)	System architectures, processing configurations. AM materials, process performance and applications, economics of additive manufacturing operations.	Know the conditions necessary to deliver accurate AM processes. Understand the causes of process variation and process strategies to reduce it. Understand the benefits and limitations of current processes.

5-6 Process Variability	Factors affecting the accuracy and precision of processes, static and dynamic effects, sources of uncertainties: inputs, process interactions, process degradation. Response to uncertainties: design of production equipment and tooling, online inspection, corrective processes	Understand the factors that affect the accuracy and precision of machining and grinding operations. Know the sources of variation in machining. Understand the various strategies used to mitigate the sources of error in machining processes.
7 - 8 Quality Control	Testing and inspection points in machining operations. Statistical process control- control charts, process improvement techniques, causes of variation, control chart patterns, control chart applications.	Understand quality control techniques in machining operations. Know how to measure and minimize process variation using statistical process control (SPC). Understand the various SPC strategies used to implement quality control measures in machining operations.

### Syllabus: Control of Production Machines and Systems

Lecture	Syllabus	On completion students should be able to ...
9 – 10 Machine automation and control	Issues in automation of machines, CNC control, Open loop and closed-loop control of m/c tools, adaptive control, sensing and actuation, robotic control	Discuss the benefits and downsides of automation Design a feedback control loop to compensate for machine tool deflection during operation Describe how sensing and actuation is achieved to implement control Describe how machine tools are automated Articulate challenges in robotic control
11 – 12 Cell Control Using PLC Programming	Issues in cell-level control, Programmable Logic Controllers, Ladder Logic Diagrams, modeling of cell operations using FSM	Understand requirements for cell automation Develop Ladder Logic code to automate the operations of a manufacturing cell Learn how to develop Finite State Machine process representations Use Finite State Machines to develop Ladder Logic Code
13 – 14 Petri Net Based Automation Modelling and Control	Introduction to Petri-Nets, modeling of cell operations using petri nets, conversion of Petri Nets to Ladder Logic	Know the rationale for selecting different discreteevent models for automated systems Understand how to develop Petri Net models Develop a cell management scheme using a Petri Net approach Convert Petri Nets to equivalent Ladder Logic code
15-16 Factory Automation & Comms	Automation options in factory wide operations. Communication systems. Future automation developments	Understand automation requirements across the factory. Learn different options for communications at different levels in the factory, Be aware of modern automation and communications developments and how they will impact on modern manufacturing

## Reading List: Operation of Production Machines

- \*Kalpakjian, Serope & Schmid, Steven R     MANUFACTURING PROCESSES FOR ENGINEERING MATERIALS, PRENTICE HALL, Edition: 0005, August 2007 (ISBN10: 0132272717, ISBN13: 9780132272711)
- \*Winston A. Knight, Geoffrey Boothroyd     FUNDAMENTALS OF METAL MACHINING AND MACHINE TOOLS, Third Edition. 2005 by CRC Press (ISBN 9781574446593)
- Helmi A Youssef, & Hassan El-Hofy     [MACHINING TECHNOLOGY](#), Taylor & Francis Ltd CRC Press Inc, 2008 (ISBN10: 1420043390 , ISBN13: 9781420043396)
- \*Ian Gibson, David Rosen, Brent Stucker     Additive Manufacturing Technologies: 3D Printing, Rapid Prototyping, and Direct Digital Manufacturing, Edition 2, Springer, Nov 26 2014, (ISBN 9781493921133)

## Reading List: Control of Production Machines and Systems

- \*BOUCHER, T.O.     COMPUTING AUTOMATION IN MANUFACTURING: AN INTRODUCTION Chapman & Hall 1996
- \*KALPAKJIAN, S. & SCHMID, S.R.     MANUFACTURING ENGINEERING AND TECHNOLOGY Prentice Hall 5th edition 2004
- BOLTON, W.     INSTRUMENTATION AND CONTROL SYSTEMS Newnes 2004
- BOLTON, W.     PROGRAMMABLE LOGIC CONTROLLERS, Newnes 4<sup>TH</sup> Edition 2006

## 3P3: Product Design

<b>Module summary</b>	Integrating engineering and industrial design in the creation of new products
<b>Taught by</b>	Prof. J Moultrie (Module Leader), Prof. M De Volder
<b>Assessment</b>	Coursework
<b>Supervision</b>	A Q&A session for the coursework will be timetabled
<b>Links to other elements of the course</b>	<p>3P1: Links to content on production processes, relevant to design for manufacture (L6), including design for injection moulding and additive manufacturing</p> <p>3P2: Links to content on machining processes and accuracy/precision relevant to lecture on tolerancing (L5) and design for assembly &amp; standardisation (7).</p> <p>3P4: Very loose link to operational complexity when considering assembly simplification in design for assembly</p> <p>CAD/CAM Exercise: requires the application of content from the lecture on Engineering Drawing and tolerancing (L5)</p> <p>IIA Major Project: Aims to put 3P3 lectures content (L1-12) into practice</p>

### Module Learning Outcomes

On completion of the module students should be able to:

1. Understand the iterative nature of the design process.
2. Understand and apply dimensional tolerances to engineering drawings.
3. Understand and apply the principles of machine design to the design of products.
4. Be able to select appropriate manufacturing processes for a new design and understand how production volume and cost influences the design.
5. Be able to assess and improve the design for assembly of an existing design. Be able to apply these ideas to a new design.
6. Understand why products are designed as they are and be able to explore a product's form.
7. Understand and be able to apply basic ergonomic principles.
8. Develop skills in sketching, conceptual design and detailed design.

### Syllabus

Session	Syllabus	On completion students should be able to ...
1 The design process	<b>1a:</b> introduction to the module & overview of the design process.	Understand the difference between a theoretical and real design processes. Be aware of the differences in competence between novice and experienced designers.



	<b>1b:</b> Improving design competence.	
2 Prototyping	<b>2a:</b> Types and roles of prototypes, simulations and models in design. <b>2b:</b> A short case study of prototyping.	Understand the importance of prototyping in the design process and the role of different types of prototype.
3 Engineering Drawing and Tolerancing	<b>3a:</b> Basics of dimensioning and drawing conventions. <b>3b:</b> Limits and fits. <b>3c:</b> Worked examples.	Produce and read engineering drawings Apply engineering tolerances.
4 Machine systems	<b>4a:</b> Machine frames and force loops. <b>4b:</b> Frame construction, joining techniques and design practices.	Application and understanding of kinematic design, force loops, flexure hinges, etc.
5 Actuators and bearings	<b>5a:</b> Introduction to different types of linear and rotating actuation principles. <b>5b:</b> Introduction techniques to guide the generated motion using bearings.	Understand that different types of actuators serve different needs. Understand the need for bearings, and be able to select the appropriate type of bearings in a design.
6 Mechanisms	<b>6a:</b> Gears and gear boxes <b>6b:</b> Linkages, cams and other mechanisms.	Understanding of the opportunities and limitations of mechanisms and how to calculate or simulate their operation.
7 Design for Assembly	<b>7a:</b> A brief history of standardisation. <b>7b:</b> Optimising an assembly – some heuristics. <b>7c:</b> Optimising an assembly – structured methods.	Be able to apply principles of design for assembly in order to simplify and reduce the cost/complexity of an assembly.
8 Design for manufacture (1)	<b>8a:</b> Unit costs. <b>8b:</b> Process selection.	Understand the importance of understanding costs and volumes in designing a new product and the impact this has on the selection of production methods and how this influences the design.
9 Design for manufacture (2)	<b>9a:</b> Design for Injection Moulding. <b>9b:</b> Design for AM.	Be able to apply design rules for manufacture, with emphasis on machining, injection moulding and 3D printing.
10 Design history	<b>10a:</b> Pre 1900. <b>10b:</b> 1900-1920. <b>10c:</b> Early modernism. <b>10d:</b> Post war. <b>10e:</b> Postmodernism and post-post modernism	Understand how industrial design developed and evolved since the start of the industrial revolution. Be aware of key design movements and their associated forms, materials, technologies and designers as well as the technological, social and economic context influencing this. Reflect on current trends and drivers in design.

11 Product form	<b>11a:</b> What a product's form communicates <b>11b:</b> Capturing design inspirations	Understand how designers create a product's form. Be able to apply some basic principles to create a product's form.
12 Physical & cognitive ergonomics	<b>12a:</b> Physical ergonomics <b>12b:</b> Cognitive ergonomics	Understand how to apply principles of design for use. Understand how we physically interact with products and how we relate to and understand products.

## Workshop activities

To support the lecture course, there will be a number of supporting activities:

1. Sketching skills session: to develop sketching confidence.
2. Design and prototyping challenge: to experience a concept design, make and test cycle.
3. Concept design exercise: to consider the design of a simple mechanism.
4. Design for assembly exercise: to put theory into practice.
5. Design for manufacture exercise: to put theory into practice.

## Assessment

The coursework will take the form of a product redesign. All students will be given a current product to use as a starting point. This will be theirs to take apart and analyse as they wish. Specifically, students will analyse the current product's strengths and weaknesses in design for manufacture and assembly. They will then redesign the product to improve its design for manufacture and assembly as well as changing the product form to make it suitable for a specific brand. Work will be submitted in the form of a design portfolio which in addition to documenting the design work will include an engineering drawing of a key component, an overall assembly drawing and a final presentation drawing. All work will be submitted and assessed anonymously. A full brief for the coursework will be provided separately.

## Reading List

*BAXTER, M.R.	PRODUCT DESIGN: A PRACTICAL GUIDE TO THE SYSTEMATIC METHODS OF NEW PRODUCTS DEVELOPMENT <u>Nelson Thornes</u> 1995 (2002 reprint)	AP 308
*ULRICH, K.T. & EPPINGER, S.D.	PRODUCT DESIGN AND DEVELOPMENT <u>McGraw-Hill/Irwin</u> 3rd edition 2004	BN 220
SLOCUM A H	PRECISION MACHINE DESIGN, 1991	AP 323

## 3P4: Operations Management

<b>Module summary</b>	The management of material and information flow in factory systems and the supply chain
<b>Taught by</b>	Dr F Erhun (Module Leader), Dr. T Masood
<b>Assessment</b>	100% by examination. Paper 3, double paper with 3P5
<b>Supervision</b>	The course will be supported by three examples papers, for each of which one supervision will be arranged. Typically Lent week 2, 4 and 8.
<b>Links to other elements of the course</b>	Production Game to simulate the operations of a manufacturing company, where students trial elements of the 3P4 module in a live setting. 3P4 has links to the 3P5 module particularly when students learn Lean and Just-In-Time manufacturing principles. 3P2 links to 3P4 as motivator for manufacturing process scheduling.

### Module Learning Outcomes

On completion of the module students should be able to:

1. Understand the ways in which manufacturing processes are managed in order to achieve the right quality of product, manufactured to meet the customer requirements and delivered on time, and making the most efficient use of the resources available.
2. Understand the role of inventory in manufacturing systems, and apply basic ordering, replenishment, and forecasting techniques
3. Describe the major influences on the efficient flow of work through a factory, apply MRP techniques to scheduling, describe the implications of different co-ordination structures on job design, describe how improvement processes relate to co-ordination strategies
4. Understand how manufacturing operations are integrated with other aspects of the business; how operations are managed across supply networks; and the role of different information systems in supporting operations across the supply chain

## Syllabus and Lecture Learning Outcomes

Lecture	Syllabus	On completion students should be able to ...
1 - 2 Introduction	Course introduction, introduction to operations management, management levers, Volume vs Variety	Discuss the key issues in manufacturing and supply chain operations and the key levers available to managers to tackle them. Discuss the importance of the volume-variety choice in process design Describe how volume-variety choice affects the manufacturing system layout Describe how volume-variety choice affects the choice of automation systems
3 - 4 Capacity Management	Capacity planning, Queuing Theory	Discuss reasons why actual capacity will be lower than theoretical and the levers that a manager can “pull” to improve capacity Discuss different options for a manager to cope with variations in demand and capacity Model a manufacturing operation as a queuing system and calculate key process parameters
5 - 6 Inventory management	EOQ, Safety stock, other inventory models	Discuss the role of inventory in a production system Derive the expression for and calculate the Economic Order Quantity Discuss the concept of safety stock in inventory management
7 - 8 Forecasting	Moving average, exponential smoothing, regression, time series analysis	Calculate demand forecasts using different forecasting methods Discuss the appropriateness of different forecasting methods
9 - 10 Scheduling	Line balancing, EDD, SPT, FIFO scheduling rules	Balance a production line Implement different production scheduling rules
11 – 12 Procurement	Materials Requirements Planning, JIT	Generate MRP records for a product and its components, given market demand and other process parameters. Discuss the differences between “push” and “pull” manufacturing approaches
13 – 14 Logistics & transportation	Transportation model, warehousing and distribution	Solve simple transportation problems for allocating product flows between supply chain locations Determine the optimal factory/warehouse location for a given demand distribution
15 - 16 Enterprise & Supply Chain information systems	SC Dynamics, ERP/SCM systems, CPFR, VMI	Discuss the implications of dynamics in supply chains Discuss the role of the information systems in improving supply chain operations Discuss various mechanisms used by organizations to coordinate product and information flows within a supply chain

## Reading List

- GOLDRATT, E.M. & COX, J. THE GOAL: A PROCESS OF ONGOING IMPROVEMENT Gower 3rd edition 2004
- \*PINEDO, M. & CHAO, X. OPERATIONS SCHEDULING WITH APPLICATIONS IN MANUFACTURING AND SERVICES Irwin/McGraw-Hill 1999
- \*SLACK, N., CHAMBERS, S. & JOHNSTON. R. OPERATIONS MANAGEMENT FT/Prentice Hall 5th edition 2007 4th edition (2004) available as e-book at: <http://ul-newton.lib.cam.ac.uk/cgi-bin/Pwebrecon.cgi?BBID=4508815> Click on 'Connect to MyLibrary resource' for access
- WOMACK, J.P., JONES D.T. & ROOS, D. THE MACHINE THAT CHANGED THE WORLD: THE TRIUMPH OF LEAN PRODUCTION Rawson Associates 1990

## 3P5: Industrial Engineering

<b>Module summary</b>	The design of production flows and operations in manufacturing
<b>Taught by</b>	Dr V. Martinez (Module leader), Dr A. Parlikad.
<b>Assessment</b>	100% by examination, consisting of 2 questions. Students will attempt all questions. Paper 3 is a double paper with 3P4.
<b>Supervision</b>	The module is supported by 3 supervisions: EP 1 – Lectures 1-6; EP 2 – Lectures 7-10; EP 3 – Lectures 11-16.
<b>Links to other elements of the course</b>	Production Game to simulate the operations of a card-manufacturing company where students trial elements of 3P4 and 3P5. Particular links between 3P4 and 3P5 exist in the application of the Just-in-time manufacturing principles. Links to the industrial visits and the major project particularly on the JIT, 5S, work measurements tools and layout planing.

### Syllabus and Lecture Learning Outcomes

Lecture	Syllabus	On completion students should be able to ...
1-2 Introduction and Method Study	Introduction to Industrial Engineering; objectives of Method Study. Method Study procedure: Select, Record, Examine, Develop, Define, Install, Maintain.	Understand and be able to apply the traditional techniques of method study.
3-4 Ergonomics	Ergonomics, principles of Motion Economy. Job Design, use of the Human Body. Arrangement of the Workplace. Design of Tools and Equipment	Understand the factors that affect the ergonomic design of jobs, tools and equipment, and the workplace.
5-6 Lean Production Techniques	Toyota Production System: JIT, 5S and Kaizen.	Understand the principles of Lean production, and be able to relate these to traditional work study.
7-8 Work Measurement 1	The Need for Time Standards. Establishing Time Standards: Activity Sampling, Time Study, Rating, Learning Curves, Allowances, Basic time, Work Content, Standard time.	Understand the roles of time standards in manufacturing. Know the different ways in which time standards can be determined and the advantages and disadvantages of each method. Understand the basic principles behind learning and be able to manipulate a simple learning model to predict the effect of learning on the cycle time of repetitive work.

9-10 Work Measurement 2	Predetermined Time Standards: MTM-1; Standard Data Systems; Activity Sampling.	Know the basic motion elements and how these are used in predetermined motion time systems. Know how standard data systems are developed. Understand work sampling is used for measuring proportion of time spent in different activities.
11-12 Process Organisation & Plant Layout	Project, jobbing, batch, line, continuous flow; cellular production; group technology Factory, Department and Workplace layout; Systematic Layout Planning.	Understand the different types of process layout and the advantages and disadvantages of each. Appreciate the factors that affect the layout of a factory. Group technology. Understand and be able to apply the techniques used in planning factory layouts
13-14 Reliability Engineering	Failure detection and prevention in factory equipment. Reliability modelling.	Discuss the basics of machine tool reliability, and explain the implications of the "bathtub curve". Understand how to calculate reliability of complex engineering systems.
15-16 Maintenance Management	Maintenance strategies Preventive maintenance planning.	Explain various maintenance strategies, their advantages and disadvantages. Understand how to develop an optimal maintenance schedule for equipment.

## Reading List

- \*GROOVER, M.P. WORK SYSTEMS: THE METHODS, MEASUREMENT, AND MANAGEMENT OF WORK Pearson 2014
- \*MUHLEMANN, A., OAKLAND, J. & LOCKYER, K PRODUCTION AND OPERATIONS MANAGEMENT Pitman 6th edition 1992
- \*BICHENO J. & HOLWEG M. THE LEAN TOOLBOX, 4<sup>th</sup> Edition, PICSIE Books,2009
- \*WOMACK JP, JONES DT, ROOS D. THE MACHINE THAT CHANGED THE WORLD, Rawson Associates, 1990
- \*IMAI M KAIZEN, Random House, 1986
- HELANDER, M. A GUIDE TO THE ERGONOMICS OF MANUFACTURING, Taylor and Francis,1995
- CHASE R, AQUILANO N.& JACOBS PRODUCTION AND OPERATIONS MANAGEMENT,8<sup>th</sup> Ed, McGraw Hill,1998
- SLACK, N., CHAMBERS, S. & JOHNSTON. R. OPERATIONS MANAGEMENT FT/Prentice Hall 5th edition 2007 4th edition (2004) available as e-book at: <http://ul-newton.lib.cam.ac.uk/cgi-bin/Pwebrecon.cgi?BBID=4508815>

## Online resources

- \*GROOVER, M.P. Book: WORK SYSTEMS: THE METHODS, MEASUREMENT, AND MANAGEMENT OF WORK Pearson 2014. \*\*\*Online book\*\*\*  
[http://idiscover.lib.cam.ac.uk/permalink/f/1ii55o6/44CAM\\_ALMA51606969690003606](http://idiscover.lib.cam.ac.uk/permalink/f/1ii55o6/44CAM_ALMA51606969690003606)
- Ergonomics Video: Five steps for ergonomic workstation.  
<https://www.youtube.com/watch?v=dVFtAEDInRA>
- Toyota production system Sugimori Y., Kusunoki K., Cho F. and Uchikawa S. (1977) Toyota production system and Kanban system Materialization of just-in-time and respect-for-human system, International Journal of Production Research, 15:6, 553-564, DOI: 10.1080/00207547708943149  
<https://www.tandfonline.com/doi/pdf/10.1080/00207547708943149>  
Spear S. and Bowen K. 1992. Decoding the DNA of the Toyota production system. Harvard Busienss Review. Sept-Oct. pp. 96-106  
<https://i9y8y5w2.stackpathcdn.com/wp-content/uploads/2015/12/Decoding-DNA-Spear-Bowen.pdf>  
Video: 5S Methodology and tips  
[https://www.youtube.com/watch?v=8gKJ3\\_Hm3dM](https://www.youtube.com/watch?v=8gKJ3_Hm3dM)  
Video: Lean 5S in MSICU - Implementaiton in practice the before and after  
<https://www.youtube.com/watch?v=aMkXICM1-98>
- Time study in work measurement Article: Preparing to measure process work with a time study  
<https://www.isixsigma.com/methodology/business-process-management-bpm/preparing-measure-process-work-time-study/>
- Preditermed time standards Research article: Heungjae Cho, Sungkun Lee & Jaeil Park (2014) Time estimation method for manual assembly using MODAPTS technique in the product design stage, International Journal of Production Research, 52:12, 3595-3613, DOI: 10.1080/00207543.2013.878480  
Research Article: Todd H.C., Chyatte S. G. and Decker R.S. 1979. Preditermed time standards: their application in workshp settings. Archives of physical medicine and rehabilitation. 60(5): 222-226  
<https://europepmc.org/article/med/156528>
- Plant Layout Video: Celullar manufacturing  
<https://www.youtube.com/watch?v=Ynhp8Wi2qwM>  
Video: Plant layout  
[https://www.youtube.com/watch?v=6FYvNrl\\_JVw](https://www.youtube.com/watch?v=6FYvNrl_JVw)
- Predictive maintenance Video: predictive maintenance explained.  
<https://www.reliableplant.com/Read/12495/preventive-predictive-maintenance>
- \*GROOVER, M.P. WORK SYSTEMS: THE METHODS, MEASUREMENT, AND MANAGEMENT OF WORK Pearson 2014  
\*\*\* Online book\*\*\*.  
[http://idiscover.lib.cam.ac.uk/permalink/f/1ii55o6/44CAM\\_ALMA51606969690003606](http://idiscover.lib.cam.ac.uk/permalink/f/1ii55o6/44CAM_ALMA51606969690003606)  
Also:\*\*\*ONLINE CHAPTERS\*\*\*  
Chapters 6, 9, 10, 11, 12, 13, 14, 15, 16, 18, 19, 21, 22, 23, and 24.  
Note: chapters available in the Engineering Department Library.



## 3P6: Organisational Behaviour

<b>Module summary</b>	An introduction to theories of organisational behaviour
<b>Taught by</b>	Dr M Kumar (Module leader)
<b>Assessment</b>	100% by examination. Paper 4, double module paper combined with 3P7
<b>Supervision</b>	There will be three supervisions on Organisational Behaviour in the Michaelmas term, typically week 4, 6 and 8.
<b>Links to other elements of the course</b>	<p>This module complements the following modules and course activities:</p> <p><b>MET IIA:</b> Industrial Visits (Corporate Social Responsibility and Sustainability); Skill Workshops (Change Management and Team Building); 3P7 (Nurturing Talent and Change Management); 3P10 (Industrial Sustainability)</p> <p><b>MET IIB:</b> MET IIB-6 (Leadership and Managing people); MET-IIB-8 (Sustainable Manufacturing)</p>

### Syllabus and Learning Outcomes

Lecture	Syllabus	On completion students should be able to ...
1 Introduction	Introducing <i>Organisational Behaviour</i>	Understand some of the central issues in work organizations Define organisational behaviour
2 Corporate Social Responsibility, and Business Ethics	Free Market Business Ethics Sustainability and Corporate Social Responsibility	Explain ethical dilemma in the workplace Describe key principles of corporate social responsibility, business ethics and sustainability
3 Culture	Levels of Organizational Culture Cultural Typology Cultural Change	Understand advantages of managing people through culture Distinguish between Schein's three levels of organizational culture Explain how managers try to change culture
4 Personality and Individual Differences	Nomothetic Approach Personality Testing Ideographic Approach Social-radical Approach	Understand key approaches to study personality Explain how personality is measured in organisational settings
5 Communication	Organizational Communication Noise Information, Communication, and Technology	Describe theories and processes of communication in organisations Explain how technology mediates communication, producing a trade-off between efficiency and richness of communication
6	Hawthorne Studies Human Relations	Describe the power of the informal organisation

Social Organisation		Explain how the Hawthorne studies lead to the foundations of organisational behaviour
7 Motivation	Extrinsic Motivators Intrinsic Motivators Behavioural, Content, Process and Social Theories	Understand what motivates people to work Use theories to identify motivational problems in organizations and recommend solutions
8 Groups and Teams	Definitions of Groups and Teams Types of teams and loafing Groupthink Social Identity Theory	Understand the differences between groups and teams Explain the link between teamwork and productivity Analyse the factors needed to produce an effective team Explain how groupthink can have negative implications on teams
9 Work Design	Rational Work design Rational Production Capitalist Working Relationship	Describe the principles behind Taylorist and Fordist rational work design Analyse the effect that Taylorism and Fordism are said to have upon workers
10 Changing the Organisation	Force-field analysis Approaches to change Three-Step Model	Describe approaches to the management of change Explain how change can be messy, causing conflict and resistance
11 Organization Design and Bureaucracy	Bureaucracy Rational Organisation Design Iron Cage Bureaucracy	State the main characteristics of a bureaucratic organization structure as specified by Max Weber Explain how bureaucracy is a form of rational organisational design
12 Leadership	Behaviourism Contingency theory Post-heroic	Describe the key leadership theories Explain the differences between leadership and management Analyse whether there is too much emphasis on the individual leader
13 Perception and Decision Making	Attribution Theory Drawback in judgments Link between perception and decision making Organizational Decision-making	Understand perception and explain the factors that influence it Identify the shortcuts Individuals use in making judgement about others Describe the common Decision Biases or errors
14 Power and Politics	Office politics Emancipation False Consciousness Empowerment	Describe the power as property view Explain why power and politics exist within organisations Analyse the different underlying assumptions
15 & 16 Review /Summary	Challenges of Organisations Changing Nature of OB Predicting Future trends	Explain the importance of connecting organisational behaviour theories Describe some of the changes that have occurred in organisations over the last forty years

## Reading List

\* HUCZYNSKI, A.A. & BUCHANAN, D. ORGANIZATIONAL BEHAVIOUR, Pearson, 8th edition 2013. Several university departments and colleges have copies of this text. You can purchase it at a 20% discount via <http://www.pearson-books.com/cam> using the voucher code ZP031F. The sixth and seventh editions are also acceptable.

ROBBINS, STEPHEN P. ORGANIZATIONAL BEHAVIOUR: CONCEPTS, CONTROVERSIES AND APPLICATIONS. Prentice Hall, 1991

KING, DANIEL, AND SCOTT LAWLEY ORGANIZATIONAL BEHAVIOUR. Oxford University Press, 2016

A list of additional readings for each topic will be made available online.

## 3P7: Managing Business and People

<b>Module summary</b>	An introduction to the processes involved in starting and running a business.
<b>Taught by</b>	Prof T Minshall (Module leader)
<b>Assessment</b>	100% by examination. Double module paper combined with 3P6 Organisational Behaviour.  Students will be required to answer one question from Managing Business and one from Managing People.
<b>Supervision</b>	There will be two hours of supervisions. Typically Lent week 5 and 8.
<b>Links to other elements of the course</b>	This module complements the following modules and course activities:  <b>MET IIA:</b> Industrial Visits ( Company Level Context, Human Resources); 3P7 (Group, Team, Motivation); 3P9 ( Firm Boundaries, Competitive Analysis, Resouces and Capabilities, Strategic Marketing, Business Models)  <b>MET IIB:</b> MET-IIB-2 (Performance Mesurement, Business Strategy, Strategic Marketing); MET-IIB-6 (Leadership and Managing people)

### Module Learning Outcomes

On completion of the module students should be able to:

5. Explain the core processes involved in starting and running a business
6. Demonstrate the importance of integrating management and business practices with the firm’s strategic objectives
7. Evaluate HR practices and the importance of making the best use of people

### Syllabus

Lecture	Syllabus	On completion students should be able to ...
1 Introduction	The key integrating frameworks for understanding a manufacturing business Module overview Key areas of activity of a manufacturing business External factors that influence a manufacturing business Frameworks to show linkages between internal and external activities of a manufacturing business	Describe and apply a framework for management of a manufacturing business and the context within which it operates

2 Entrepreneurship	<p>Starting and growing a business</p> <p>The role of entrepreneurship in an economy</p> <p>Defining entrepreneurship: Resource-based versus opportunity based activities</p> <p>How a firm grows: Typical growth trajectories and common management challenges</p>	Describe entrepreneurial activity and its place in the economy, and to outline the most significant challenges faced by those managing a young firm
3 Staying competitive	<p>Guiding and managing an established business</p> <p>Managing steady state c.f. managing change</p> <p>Tools for planning</p> <p>Managing Innovation (product, process, business model, organisational, etc)</p>	Explain the challenges faced in managing an established business, and some of the tools available to assist in planning and implementing change
4 Marketing	<p>Identifying future business opportunities</p> <p>The business planning cycle</p> <p>Identifying customer needs and opportunity areas</p> <p>Designing business models to address new needs</p>	Outline the marketing function and its contribution to the business
5 Sales	<p>Accessing customers (PBH)</p> <p>The links between business models and routes to market</p> <p>The key tools and techniques for sales</p> <p>Integrating sales with other business activities</p>	Describe the sales process, its role in the business, and a selection of key tools and techniques
6 Case study	<p>Integrating example</p>	Discuss how the principles covered in lectures 1 to 5 might be applied practice
7 Introduction to HRM	<p>Managing people to deliver business objectives</p> <p>People as a resource</p> <p>The principles of HRM (and contrasts with earlier models)</p> <p>The application of HRM (Hard &amp; Soft; integrated, devolved, outsourced)</p> <p>Strategic HRM</p>	Describe the core principles of HRM and discuss its practical application
8 Recruitment and Selection	<p>Establishing the need for recruitment; establishing processes to attract good employees to the organisation; and identifying the best mechanism for selection.</p>	Understand the supply-side factors that influence recruitment and describe the main components of the employee recruitment process.

9 Performance management	Goals of performance measurement Performance appraisals Potential biases in appraisals Stack ranking 360 degree appraisals Appropriate employee compensation and different means of achieving it	Describe how employee performance is measured and managed.
10 Nurturing talent	Models of learning Training/learning methods Segmenting talent Employee retention	Discuss the process of employee learning and different methods of training employees Describe how employee talent should be recognised and managed effectively to deliver value to the organisation
11 Change Management	Types of change in organisations Resistance to change and overcoming resistance Satir Model of change Kotter's 8 steps for successful change management	Discuss why change is an issue for organisations Describe the implications of change for the management of people
12 Legislation and regulation	Managing within the legal framework Employment law (hiring, firing, equal opportunities etc) Workplace legislation Employee participation and consultation	Describe the main features of the regulatory and legal framework for employment
13 Dispute Resolution and Governance	Managing people within a framework Dispute resolution Governance and ethics in HRM (inc objective-subjective perspectives)	Outline the main features of the frameworks within which employees are managed, and explain modern approaches to dispute resolution.
14 International practices/Globalisation	Addressing diversity - Cultural and regulatory variations; Pan-national influences Universalist and contextualist paradigms Convergence and divergence Cultural and institutional explanations Variations in practice	Explain, with examples, how cultural and national norms influence the nature and practice of HRM
15 Current trends	including globalisation, new technology, demographics, flexible working, outsourcing (People management) Technology in HRM Dynamic organisations	Demonstrate awareness of current trends and developments in HRM and in the management of people
16 Review/Summary	Integrating people, management practices, and business strategy	Explain and illustrate how strategic, operations and human resource management practices interact in the process of starting and running a business

## Reading List

- \*MOORE, G            CROSSING THE CHASM, New York: Harper Business 1991
- \*MULLINS, J. W     THE NEW BUSINESS ROAD TEST: WHAT ENTREPRENEURS AND  
EXECUTIVES SHOULD DO BEFORE WRITING A BUSINESS PLAN.  
London, FT Prentice Hall. 2003
- \*STOREY, J. (ed)    HUMAN RESOURCE MANAGEMENT: A CRITICAL TEXT            1844806154  
Thomson Learning 3rd edition 2007
- \*TIMMONS, J. A.    NEW VENTURE CREATION: ENTREPRENEURSHIP FOR THE 21<sup>ST</sup>    0071276327  
& SPINELLI, S     CENTURY McGraw-Hill 8<sup>th</sup> edition, 2008
- \*BEARDWELL, J.,    HUMAN RESOURCE MANAGEMENT: A CONTEMPORARY            0273707639  
& CLAYDON, T.     APPROACH Financial Times/Prentice Hall 5<sup>th</sup> edition 2007
- \*LEGGE, K            HUMAN RESOURCE MANAGEMENT: RHETORICS AND            1403936005  
REALITIES, Palgrave Macmillan, 2005

## 3P8: Financial and Management Accounting

<b>Module summary</b>	An introduction to the principles and practice of financial & management accounting and finance
<b>Taught by</b>	Dr J Plummer-Braeckman (Module leader)
<b>Supporting activities</b>	The module content is used in the production of business plans for the major project
<b>Assessment</b>	100% by examination, Paper 5 combined with 3P9 Economics of Industry and Strategy
<b>Supervision</b>	Four supervisions will be offered in support of this module, typically weeks 3, 5, 7 and 8.
<b>Links to other elements of the course</b>	There are some links to 3P4, Operations Management, in particular inventory management. There are also links to 3P9, Industrial Economics, Strategy and Governance. This work also supports capabilities needed within the Major Project.

### Aims

The course is designed to situate management and shareholders' decision making in their financial context. The course aims to develop students' understanding of the financial processes affecting corporate life - in particular, their understanding of the factors impinging upon corporate decisions and of the financial aspects of organisations.

### Syllabus: Financial Accounting

Lecture	Syllabus	On completion students should be able to ...
1-2	Overall framework of financial reporting	Understand the importance of financial accounting. Understand the principles, conventions and regulatory framework of financial accounting.
3-4	The mechanics of accounting Balance Sheet, Profit and Loss Account/Income	Understand the principles of double entry bookkeeping. Understanding the principles of preparing of company financial statements such as the Profit and Loss Accounts and the Balance Sheet
5-6	Asset valuation methods, cash flow statements	Understand different methods of asset valuation and the purpose and creation of cash flow statements
7-8	Performance ratios Analysing and interpreting financial statements Creative accounting	Understand and be able to use firm performance ratios. Be familiar with company reports and their analysis, be able to compare performance of firms. Awareness of creative accounting and possible management of earnings.



## Syllabus: Management Accounting and Finance

Lecture	Syllabus	On completion students should be able to ...
9-10	Cost concepts and cost behaviour Product costing systems and activity based costing	Understand the classification of different costs Understand and be able to apply different costing methods and to apply different methods for dealing with overhead costs
11-12	Building a budget Budgeting and variance analysis/cash flow management	Understand budgeting methods and processes. Understand and be able to apply variance analysis, and manage the cash in a business.
13-16	Investment Appraisal Financing decisions	Understanding the approaches to compare the financial viability of different projects <ul style="list-style-type: none"> <li>- payback calculations</li> <li>- capital budgeting decisions (opportunity cost of capital, investment rules such as net present value and real options)</li> <li>- time value of money and risk versus return;</li> <li>- financing decisions (debt versus equity).</li> </ul> Understand financing decisions (debt versus equity) and the capital markets.

### Reading List

ATRILL, P. & McLANEY, E.J.	ACCOUNTING AND FINANCE FOR NON-SPECIALISTS <u>Pearson</u> 11th edition 2018
ATRILL, P. & McLANEY, E.J.	FINANCIAL ACCOUNTING FOR DECISION MAKERS <u>Pearson</u> 9th edition 2019
ATRILL, P. & McLANEY, E.J.	MANAGEMENT ACCOUNTING FOR DECISION MAKERS <u>Pearson</u> 9th edition 2019
BARKER, R.	SHORT INTRODUCTION TO ACCOUNTING, <u>Cambridge University Press</u> , 2011
ATKINSON, A.A., <i>et al.</i>	MANAGEMENT ACCOUNTING: INFORMATION FOR DECISION MAKERS AND STRATEGY EXECUTION <u>Pearson</u> 6th edition 2011
ROSS, S.A., WESTERFIELD, R.W. & JORDAN, B.D.	FUNDAMENTALS OF CORPORATE FINANCE. McGraw-Hill Irwin. 13th ed. 2022.

## 3P9: Industrial Economics, Strategy and Governance

<b>Module summary</b>	An introduction to the principles and practice of economics in order to understand the structure of industries and corporate strategy
<b>Taught by</b>	Dr F Urmetzer (Module leader)
<b>Assessment</b>	100% by examination, Paper 5, combined with 3P8 Financial and Management Accounting
<b>Supervision</b>	Four supervisions will be offered in support of this course
<b>Links to other elements of the course</b>	There are links to 3P8, Financial and Management Accounting. This work also supports capabilities needed within the Major Project.

### Aims

The course is designed to situate firm practices and decisions in their wider economic context. The course aims to develop student understanding of the global economy and the evolving structure of industries and firms. It explores the key aspects of strategy formulation and the management of firms that shape the development of business.

### Syllabus: Industrial Economics

Lecture	Syllabus	On completion students should be able to ...
1-2	The Global Economy, markets and industries The importance of manufacturing The rise of the service economy The role of strategy and strategic planning	Understand the global economy and the changing structure of markets and industries. Understand the development of the manufacturing and service industries. Appreciate of different views of strategic planning
3-4	Firm boundaries	Understand the theory of the firm Understand the horizontal and vertical boundaries of the firm
5-6	Competitive analysis	Appreciate the analytical framework of standard microeconomics. Understand the principles of models of perfect competition, monopoly and oligopoly. Understand the economics of entry and exit Understanding dynamics of competing across time
7-8	Industry and strategic positioning	Appreciate the main issues affecting the macro environment Understand the benefits of cooperation Analyse how firms may respond strategically to its changing environment. Understand strategic positioning and competitive advantage

9-10	Resources and capabilities	Appreciation of positioning versus resource base view Sustaining competitive advantage
13-14	Strategic marketing	Understand the role of marketing in the execution of strategy Appreciation of marketing objectives and strategies Understand product and pricing Understand distribution and promotion
11-12	Business models and innovation	Understand the relationship between strategy, business models and tactics and its relationship to innovation
15-16	Strategy and governance	Appreciate departmentalisation, coordination and control Appreciate of organizational structures Understanding efficient information processing

### Reading List

- BESANKO, D., DRANOVE, D., SHANLEY, M. & SCHAEFER, S. ECONOMICS OF STRATEGY, 6<sup>th</sup> edition, Wiley. 2013
- KOTLER, P., KELLER, K.L. & BRADY, M. MARKETING MANAGEMENT. Prentice-Hall/Pearson Education Global edition 2015
- GRANT, R. CONTEMPORARY STRATEGY ANALYSIS: Text and Cases, 8<sup>TH</sup> edition, Wiley, 2013

## 3P10: Contemporary Issues in Manufacturing.

<b>Module summary</b>	a. Integrative industrial visits to study modern industrial practice b. Lectures to introduce current topics
<b>Taught by</b>	Dr R Daly (module leader), Dr C Barlow
<b>Supporting activities</b>	The module is linked with the industrial visits, which will enhance understanding of all lecture modules and provide examples of their application in modern manufacturing companies.
<b>Assessment</b>	100% by examination. There will be a 90 minute examination in which students will be required to answer one question from each of the three sections – (i) industrial sustainability, (ii) bio engineering and medical device manufacturing and (iii) scaling up to manufacturing
<b>Supervision</b>	a. Whole debriefing for each industrial visit, group feedback sessions b. Industrial Sustainability - One review and discussion class for the whole group (1.5h) c. Bioengineering & Medical Device Manufacturing - One examples paper and class for whole group (1.0h) d. Scaling up to Manufacturing – One examples paper and class for whole group (1.0h)
<b>Links to other elements of the course</b>	METIIA 3P1: We look at materials used specifically for medical technologies. METIIA 3P3: There are specific design for manufacturing challenges for medical technologies METIIB-3 Technology and Innovation Management (New product innovation) METIIB -6 Production Technologies and Materials (Sustainable materials, materials analysis for QC) METIIB-7 Sustainability Manufacturing

### Syllabus: Industrial sustainability

Lecture	Syllabus	On completion students should be able to ...
1 The big picture	The industry landscape: The eco-impact of industrial activity. Energy and resource usage and security. “Triple bottom line”	Assess the contribution of industry to carbon emissions Discuss major resource implications relevant to manufacturing industry
2 The detailed picture	Measurement and legislation How do we assess the eco-impact of industry? What can we measure and how can we compare different	Explain where the eco-impact of industry arises, including the role of supply chains and the implications of the product lifecycle Know what the legislation is

	environmental stressors? ISO, LCA., 'LCA Light'	Discuss the strengths and weaknesses of different metrics
3 Mitigation measures	How can eco-efficiency be improved? Design for sustainability Optimising materials and process selection The role and limitations of recycling Waste reduction measures Paradigm shifts: Product service systems; zero waste systems	Choose materials and processes to minimise eco-impact Discuss the role and limitations of recycling Identify sources of waste and suggest how waste may be reduced Be aware of radically different ways of meeting materials needs of society
4 Effecting industrial change	How and why do companies 'go green'? Case studies	Assess the eco-impact of a company and make reasoned proposals for how to reduce it.

### Syllabus: Bioengineering & Medical Device Manufacturing

Lecture	Syllabus	On completion students should be able to ...
1	Introduction to medical devices, materials, required properties and tissue engineering	Understand the breadth of the medical device industry and the classification of devices. Display familiarity with the range of synthetic and biomaterials used to form medical devices.
2	Selected key challenges in manufacturing of medical devices.	Explain the specific challenges faced in manufacturing of medical devices, e.g. sterilisation, biocompatibility.
3	The medical device industry Sector analysis in UK and international context Regulatory bodies and their influence on manufacturing Bioethics	Explain the essential features of the medical device industry. Show an understanding of the regulatory procedures that are followed. Understand the development of bioethics as a field and the key principles of bioethics
4	Future trends in medical devices and potential impact on manufacturing. E.g. Nanomanufacturing, personalised medicine	Show awareness of trends in the industry and identify the challenges they pose to manufacturing.

### Syllabus: Scaling up to Manufacturing

Lecture	Syllabus	On completion students should be able to ...
1	Introduction to multiple dimensions of scale-up and links to other modules Case-studies of scale-up challenges	Understand the multidimensional nature of scale-up in manufacturing Systematically think through the scale-up challenges for an emerging technology Understand the use of frameworks to support scale-up
2	Introduce risks leading to the Valley of Death	Assess combination of risk factors when scaling up

	Techniques for risk management	Understand and describe a range of management tools for scale-up Understand the industrial innovation infrastructure needed to address risks
3	Challenges of scale-up can be addressed through contributions from science, engineering, industry and policy Innovation infrastructure for scale-up	Understand the importance of supporting generic and infra technologies Understand the international approaches to addressing scale-up risks

### Reading list – Industrial Sustainability

- ALLWOOD, J.M., CULLEN, J. *Sustainable materials – with both eyes open*  
Available as download from the web <http://www.uit.co.uk/B-SMWBE0/>
- ASHBY, M.F. *Materials and the environment*, Butterworth-Heinemann 2009, ISBN 978-1-85617-608-8
- VON WEISZACKER E, LOVINS A.B., LOVINS L.H. *Factor Four: doubling wealth, halving resource use*. Earthscan publications, 1997,
- MACKAY, DJC *Sustainable energy – without the hot air*, [www.withouthotair.com](http://www.withouthotair.com), 2008

### Reading List – Bio Engineering: Medical Devices and Bio materials

- RATNER, Buddy D. *Biomaterials science an introduction to materials in medicine*, Elsevier Academic Press, 2004
- SINGER, P.A., VIENS, A.M. *Cambridge Textbook of Bioethics*, Cambridge University Press, 2008
- WORLD HEALTH ORGANISATION *Medical Device Regulations- Global overview and guiding principles*, Geneva, 2003, ISBN 92 4 154618 2.

# Coursework

## CAD/CAM Exercise

<b>Coursework summary</b>	Aims to develop and test the student's ability to produce engineering drawings using CAD, turn the CAD drawings into programmes for the production of the components, and operate the machine tool to produce the parts
<b>Taught by</b>	Alan Thorne, Dr J Moultrie
<b>Assessment</b>	Coursework
<b>Links to other elements of the course</b>	From -MET IIB - 3P2 (Tools, Feeds & Speeds - B. O'Neill) From -MET IIA – Workshop Practical (Machining – A. Thorne) From -MET IIA – Drawing / Tolerancing Lectures (J. Moultrie) To -MET IIB - MSE (Robot Lab - A. Thorne / D. McFarlane) To -MET IIA - 3P3 (Major Design Project - J. Moultrie / M. De Volder)

### Overview

The CAD/CAM coursework aims to develop and test the student's ability to produce engineering drawings using CAD, turn the CAD drawings into programmes for the production of the components, and operate the machine tool to produce the parts. The coursework contributes 30 marks. The group will be split into half, with one half producing drawings and programmes for the machining of a milled component, the other half for a turned component.

The CAD exercise is to be completed using SolidWorks. The CAM work is to be produced using SolidCam. There will be classroom support early in Michaelmas term in the use of both software packages.

Students will work in pairs, and be assessed as a pair.

### Deliverables

Students will be provided with a simple assembly of 3 parts, 2 of which will have an engineering drawing. Each pair will be required to:

- produce a complete engineering drawing of the 3<sup>rd</sup> component in the assembly. This must be approved before any programming can begin;
- produce a programme to be loaded onto the machine tool.

### Electronic Submission (via Moodle)

The CAD drawings must be electronically submitted on or before **17:00 Friday 28<sup>th</sup> October**

**Your drawing must include your candidate numbers.** A pdf file of your engineering drawing is to be electronically submitted via Moodle submissions, using the following file name structure, where you replace the numbers with your own: **1234n\_5678x\_CAD\_date.pdf**



The CAM programmes must be submitted electronically on or before **17:00 Thursday 1 December** via Moodle submissions. To hand in the CAM component of coursework, please create a zip file, named using the following convention: **1234n\_5678x\_CAM\_date.zip**

### **Assessment**

The coursework is worth 30 marks in total.

- CAD drawing: 50% marks, awarded for completeness, clarity, precision and presentation. Individual drawing will be 'marked-up' with suggested changes, much as would be done in industry by a senior engineer.
- CAM programme: 50% marks, awarded for elegance in programming

# Production Game

## Introduction

The Production Game is a simulation of a manufacturing operation. Small companies (teams) are required to manufacture simple paper-based products (greeting cards) based on orders from a market place. Products which meet the required standards of quality and delivery are purchased by the market. Unacceptable products are rejected.

The Production Game typically provides a rich array of first-hand experience with which to think about the issues involved in the organisation and control of manufacturing systems.

Students are required to electronically submit two reports, a pre-game report, and a final report.

## Deliverable 1: pre-game report

Each team is required to submit a report before the game starts outlining the following:

- Resource allocation: How are your resources going to be allocated?
- Production Layout: Are you going to go for a functional or a product-based layout?
- Order selection: What type of orders would you pick?
- Coordination and control: What co-ordinating (integrating) and scheduling mechanisms are you going to use?
- It is important to not only describe the strategies, but to describe the manner in which the strategy was formulated. Prior preparation (e.g., time study, cost-benefit analysis) will pay dividends.

## Deliverable 2: Final report

Final report (individual): Each student should produce a report of a maximum of 2000 words in length which analyses the performance and activities of their company during the Game. Where appropriate, draw on material from 3P3 and 3P4 in your report. The report should include treatment of at least some of the following issues:

- Did your strategy prove to be correct – if so, why, if not, why not?
- How did you design, organize and control your manufacturing system? How did this reflect your wider strategic decisions vis a vis the market? What methods did you use to control costs, quality, time etc?
- How was whole enterprise managed? For example, how did coordination between 'Marketing and Sales' and 'Manufacturing', and 'Manufacturing' and 'Purchasing' occur? What formal and informal information systems were designed (or evolved) during the game? How appropriate were these?
- The things that you feel you did right, and the major errors you made; how you would do it differently next time.
- Comparisons between the performance and processes of your company and those of the other firms. Were there any patterns in who did well and who did badly?

## **Evaluation**

The coursework will be marked out of 30, with the following allocation of marks to different activities:

- Pre-game report 50%
- Final report 50%

Standard filenames for electronic submission through Moodle submission in the following format please:

Your coursework number followed by the coursework name and date

e.g. **1234n\_ProdGame\_date.pdf**

# Major Project

<b>Project summary</b>	A major group design project seeking to apply learning from 3P3 and to integrate different elements of MET
<b>Taught by</b>	Prof. James Moutlrie (Project Leader), Prof. Michael De Volder
<b>Assessment</b>	Coursework
<b>Supervision</b>	The staff meet with students during timetabled session on Thursday mornings to discuss progress and to steer the project. We also hold 2 formal supervisions with each team to discuss team member contributions and provide feedback on progress; these are recorded in CamCors.

## Overview

The Major Project runs from the end of Michaelmas term until the end of the academic year and aims to integrate the design, manufacturing and management elements of the course.

The main components of the project are the development of a viable design solution to a genuine problem or issue, in tandem with understanding the market and producing a comprehensive business plan. The business plan will also include some detailed analysis of the financial viability of the product.

A brief for the project will be circulated to students during Michaelmas term, before the project starts. In previous years, briefs have included: “develop a new Additive Manufacturing technology” and “develop a piece of production technology to help manufacturing a better future.”

## Learning Outcomes

At the end of the project, students should have:

- Applied their engineering design skills to solve technical problems.
- Applied their industrial design skills to develop solutions which are fit for the intended users, appropriately styled and clearly explained visually.
- Applied their knowledge of materials and production engineering to develop solutions that could be produced in volume.
- Explored issues relating to environmental, economic and social sustainability relating to their products.
- Gained experience in market and user research.
- Applied their skills in financial analysis to develop a robust business model for their proposed designs.
- Developed their skills in producing a compelling and believable business plan.

## Assessment

Detailed assessment criteria will be outlined in the Major Project briefing during Michaelmas term. In total, the project contributes 140 marks.

# General information

## Penalties for late hand in of coursework or missing an industrial visit

There are automatic penalties for late submission of any piece of coursework. The penalty will be **20% of marks per week, or part week, that the work is late.**

There are automatic penalties for missing an Industrial Visit without prior approval. See Visit section of the handbook.

Coursework extensions requested prior to the hand in date, notification of missing a visit prior to visit, or any mitigating reasons for a late hand in or a missed visit, must be accompanied by a METIIA Coursework Allowance form signed by your college tutor. An Allowance form can be obtained from the IfM Teaching Office ([met-admin@eng.cam.ac.uk](mailto:met-admin@eng.cam.ac.uk))

## Reasons for arranging coursework or missing Industrial Visits

Reasons for seeking to rearrange course work or missing an Industrial Visit fall into one of the following five categories:

### Illness

Educationally it is always preferable to rearrange coursework missed through illness, and this should be attempted wherever practicable. If rearrangement is not possible, then students should apply for the appropriate allowance.

'Illness' is broadly defined as any illness, mental health problem, physical injury or other grave cause which, in the opinion of both the student's tutor and the METIIA Course Director, prevents the student from completing their scheduled coursework activities on time, or in some cases at all.

### Compassionate or religious grounds

Students will, wherever practicable, be allowed to rearrange coursework, or miss visits, on compassionate or religious grounds (for instance, to enable them to attend a funeral, or because the coursework is scheduled on the day of a religious festival). The student concerned should try to rearrange the coursework in advance. If rearrangement proves impossible, then an application for an allowance may be made with the support of the student's tutor.

### Interviews

When applying for jobs, work placements or sponsorship, students may be invited for interview on days that conflict with coursework activities and visits. Students should in the first instance seek to rearrange the interview rather than the coursework or visit. If this proves impossible, then the student should try to rearrange the coursework. Allowances are not normally given for coursework missed through interviews. For a missed industrial visit, an application for an allowance may be made with the support of the student's tutor.

### Sporting commitments

Coursework and visits may **not** be rearranged to accommodate **College** sporting commitments. Students will, wherever practicable, be allowed to rearrange coursework that conflicts with **University** sporting competitions (i.e. representing the University of Cambridge in a competitive event) but not for training sessions. For a missed industrial visit, an application for an allowance may be made with the support of the student's tutor.

# Workshop Practical

<b>Workshop summary</b>	The objective of this workshop practical is to provide MET IIA students with a basic understanding of fabrication skills
<b>Taught by</b>	Alan Thorne (Workshop Leader), Simon Sennitt, Chris Jennings
<b>Assessment</b>	<b><u>This activity is not marked</u></b> (Training for use of studio & workshop equipment)
<b>Links to other elements of the course</b>	To - MET IIB - MSE (Robot Lab - A. Thorne / D. McFarlane) To - MET IIA - 3P3 (Major Design Project - J. Moultrie / M. De Volder) To - MET IIA - 3P2 (Machine Configurations, Stiffness, Finishes - B. O'Neill) To - MET IIA – CAD / CAM (CNC / Mutli Axis Machining – A. Thorne)

## Overview

The objective of this workshop practical is to provide MET IIA students with a basic understanding of fabrication skills required to:

- a) Produce prototyped components using 3D printing, laser cutting and vacuum forming processes.
- b) Produce actual components using more traditional production processes such as turning, milling and electronic assembly techniques.

The workshop sessions have been designed to enable students to produce components required for the fabrication of a perpetual pendulum. The pendulum makes use of an electro-magnet to provide the pendulum with pulses of energy to overcome losses in the mechanical system.

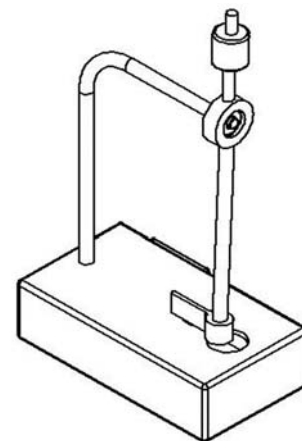

The pendulum blister pack and transport jig will be made using Rapid Proto Type (RPT) technologies. The Pendulum body, arm and base containing the electromagnetic drive will be made using more traditional production processes.

Students will be asked to attend two workshop sessions. The first workshop session will focus on skills required to use the RPT equipment within the design studio. An option of two RPT sessions will be scheduled, each accommodating up to half of the class. The second workshop session will focus on skills required to operate hand tools, machine tools and electronic fabrication tools within the IfM workshop. A series of workshop sessions will be scheduled, each accommodating a maximum of four students. Students will be asked to sign up to workshop sessions on a first come first served basis.

At the end of the workshop sessions the students are expected to have a good understanding of the different production processes as well as the use of various equipment in a safe

manner. Successful completion of this activity will allow students to utilise the facilities within the IfM for other project activities such as the Design Project and CAD/CAM.

### **Information**

- Students will complete a safety questionnaire before entering the workshop.
- Students should be appropriately dressed to work within a workshop environment. Closed toe shoes, no loose clothing or jewellery and hair tied back. (Lab coats and safety glasses will be provided.)



# The Overseas Research Project (ORP)

## Aims

The aims of the Overseas Research Project (ORP) are to:

- i. expose students to a broad cross section of current practice in international manufacturing;
- ii. experience in an integrated manner the application of the course material in a range of industrial settings;
- iii. enable the students to practice project management and team working skills;
- iv. expose students first hand to the importance of stakeholder management.

## ORP Process

**When:** The METIIB ORP takes place in the 4<sup>th</sup> year, during a two week period following the end of the Easter term. Some preparation time is allocated within the MET IIB timetable but most of the work is extracurricular. However, METIIA students should start their ORP preparation during the 3<sup>rd</sup> year.

**Who:** A staff member is appointed in an advisory/ supervisory role but the project is organised and delivered by the MET IIB students as a group.

**How:** Towards the end of the 3<sup>rd</sup> year, students are responsible for identifying a research location and topic (in discussion with the MET IIB Director and relevant MET staff and researchers). During the 4<sup>th</sup> year students will arrange visits to companies, coordinate with MET Administrator to arrange travel and accommodation and secure sponsorship to fund the ORP. Due to tightened budgets, the Engineering Department is not in a position to provide finance for the ORP. However, the IfM Teaching Office will provide matched funding of £50 for each student, subject to each student contributing an equal amount.

**Reporting:** The key deliverables from the project are a report on the identified research theme and a presentation at the IfM. Students are responsible for the detailed content of the report, though this must be signed off by the MET IIB Director prior to dissemination.

**Assessment:** The ORP itself is not assessed but parts of the background research may be used as examples in the synoptic examination papers.

**Finance:** The University has very strict rules on how money is received and paid out. Before committing to any financial arrangements, transactions or commitments, you must check with the MET Administrator to make sure you do not inadvertently break any University finance rules.

## Key actions and timings

When	What
By the end of MET IIA	<p>Appoint the student project leader and three team members responsible for sponsorship, research and logistics respectively.</p> <p>Agree the research location. Plan B is essential.</p> <p>Outline the research topic or options.</p>
Over the summer break	<p>Continue planning.</p> <p>Keep MET IIB Director. MET Administrator, Mukesh Kumar and IfM-ECS Communications Officer informed of developments.</p>
By start of METIIB Michaelmas term	<p>Identify and contact potential sponsors.</p> <p>Develop a refined statement of the research topic.</p> <p>Draft the project brochure for sending to sponsors and companies, in discussion with IfM-ECS Communications Officer.</p>
As early as possible	<p>Confirm the outline of the programme.</p> <p>Identify target companies for visits.</p> <p>Negotiate timing of visits to companies.</p> <p>Confirm with the MET IIB Director who from IfM will be accompanying the tour.</p>
Preparing the Project Report	<p>Much of the report should be prepared before the tour. This should certainly include the literature review, and the research questions and methodology. The structure of the final report should also be clear.</p> <p>During the tour it is important to have daily reviews of the visits, and for individuals to be responsible for writing up the results of each visit.</p>
Following the tour	<p>Immediately on return from the tour <b>students should complete the project report</b>, which must be signed-off by the MET IIB Director before publication.</p> <p>IfM-Engage Communications Officer will be able to assist with the dissemination of the report.</p> <p>A presentation summarising the report should be arranged as part of the IfM Friday Seminar Series (coordinated by Dr Yongjiang Shi)</p>

## Technology Libraries Team

The Technology Libraries team provide specialist information and library services support for the departments of Engineering, Computer Science and Chemical Engineering and Biotechnology.

Based in the Engineering Library in the Baker Building on Trumpington Street and at the West Hub on JJ Thomson Avenue, the team is available in person and online to help with any questions you may have about resources, search strategies, managing references and more.

The team provide a range of teaching and training of topics ranging from finding the resources you need for your projects to poster design and presentation skills to time management. You can explore the range of [open sessions](#) that you are welcome to attend. We can also be contacted for 1-1 or small group support at anytime throughout your course.

[Visit the website](#) to discover the range of services and support available to you.

Contact the team [techlib@lib.cam.ac.uk](mailto:techlib@lib.cam.ac.uk) or come and say hello at one of our libraries.

## Further Library Support

Other libraries at Cambridge that may have further resources to support your studies include:

### [The University Library](#)

Home to huge research collections and a wide range of spaces to study.

### [Judge Business School Information & Library Services](#)

Providing a specialist information and library service in the field of business and management studies, including a large range of specialist databases and electronic resources.

[Visit the website](#) to find out more and how to register for access.

# Appendix 1: Referencing and Plagiarism

## Guidance on referencing, collaboration and plagiarism

1. The confidence which a reader has in the contents of a report, paper or dissertation is based on trusting the author. An important contribution to building that trust is through the author demonstrating clearly how they have built on the work of others, and giving full credit to previous contributions, as well as identifying unambiguously which parts of the overall work are their own, original contribution. That is the role of references in technical writing: to give recognition to other people's work and to provide an 'audit trail' of links to previous work. Developing a good style of referencing takes some effort; in many cases, facts and ideas are so well known and standard that no reference is needed, but if you have any doubts about whether the reader might misinterpret the extent of your own contribution you should always refer explicitly to the source of previous work.
2. In some of your work you will collaborate with other students. Not only does this often make sense in terms of splitting up a larger task into smaller parts, but it can also be a very fruitful method of generating new ideas. Learning how to manage and work within a collaborating team forms an important part of your training as an engineer. In some cases work which results from a team effort will be assessed for examination credit. In such cases all authors of the work must be clear among themselves as to which parts have been contributed by each member, and where required by the Examiners this should be indicated by initials at the bottom of each page.
3. If a report contains material of which you (or in the case of a collaborative report, a member of your team) are not the originator, then you must make the origin of the material explicitly clear by suitable references. Not to do so constitutes plagiarism, which is defined as 'submitting as your own work material which derives in part or in whole from the work of others without due acknowledgement'. Wherever you use sources of information or data such as books, journal articles, internal company sources, personal interviews, web-sites or other internet resources you should ensure that they are fully referenced, so that the reader can locate the source and if necessary make an independent judgement of the quality of the information. You should include text which you have not generated yourself only if it is clearly marked as a quotation (e.g. by placing it in quotation marks with a full reference to its source).
4. Plagiarism is both poor scholarship and a breach of academic integrity, and is regarded extremely seriously within the University. Plagiarism is a form of cheating and any incident in work assessed for examination credit will be reported to the Head of Department, who will normally refer the matter to the University Proctors.
5. Forms of plagiarism include copying someone else's language and/or ideas as if they are your own by, for example, quoting verbatim, paraphrasing, cutting and pasting from the internet, or submitting someone else's work as part of your own without full and explicit acknowledgement of the source. Plagiarism applies to all types of sources and media, whether published or not.

6. The guiding principle is that Examiners and others who may read your work must be in no doubt as to which parts of it are your own original work and which parts are the work of others, or have been produced by you in collaboration with others.
7. These guidelines apply to all assessed work: for example, coursework and project reports.
8. Further guidance can be found in the statement of the University's Policy on Plagiarism at [www.admin.cam.ac.uk/univ/plagiarism](http://www.admin.cam.ac.uk/univ/plagiarism). If you are uncertain about these guidelines or have any questions about their application, the MET Course Director will be glad to provide advice.

## University of Cambridge General Board Statement on Plagiarism

The General Board, with the agreement of the Board of Examinations and the Board of Graduate Studies, has issued this guidance for the information of candidates, Examiners and Supervisors. It may be supplemented by course-specific guidance from Faculties and Departments.

Plagiarism is defined as submitting as one's own work that which derives in part or in its entirety from the work of others without due acknowledgement; or, in the case of self-plagiarism, unless explicitly permitted by regulation, submitting one's own work that has already been submitted for assessment to satisfy the requirements of any other academic qualification, or submitted for publication without due acknowledgement. It is both poor scholarship and a breach of academic integrity.

Examples of plagiarism include **copying** (using another person's language and/or ideas as if they are a candidate's own), by:

- *quoting verbatim another person's work without due acknowledgement of the source;*
- *paraphrasing another person's work by changing some of the words, or the order of the words, without due acknowledgement of the source;*
- *using ideas taken from someone else without reference to the originator;*
- *cutting and pasting from the Internet to make a pastiche of online sources;*
- **submitting** *someone else's work as part of a candidate's own without identifying clearly who did the work. For example, buying or commissioning work via professional agencies such as 'essay banks' or 'paper mills', or not attributing research contributed by others to a joint project.*

**Plagiarism might also arise from** colluding with another person, including another candidate, other than as permitted for joint project work (i.e. where collaboration is concealed or has been forbidden). A candidate should include a general acknowledgement where he or she has received substantial help, for example with the language and style of a piece of written work.

Plagiarism can occur in respect to all types of sources and media:

- *text, illustrations, musical quotations, mathematical derivations, computer code, etc;*
- *material downloaded from websites or drawn from manuscripts or other media;*
- *published and unpublished material, including lecture handouts and other students' work.*

Acceptable means of acknowledging the work of others (by referencing, in footnotes, or otherwise) vary according to the subject matter and mode of assessment. Faculties or Departments should issue written guidance on the relevant scholarly conventions for submitted work, and also make it clear to candidates what level of acknowledgement might be expected in written examinations. Candidates are required to familiarise themselves with this guidance, to follow it in all work submitted for assessment, and may be required to sign a declaration to that effect. If a candidate has any outstanding queries, clarification should be sought from her or his Director of Studies, Course Director or Supervisor as appropriate.

Failure to conform to the expected standards of scholarship (e.g. by not referencing sources) in examinations may affect the mark given to the candidate's work. In addition, suspected cases of the use of unfair means (of which plagiarism is one form) will be investigated and may be brought to one of the University's Courts. The Courts have wide powers to discipline those found guilty of using unfair means in an examination, including depriving such persons of membership of the University.

The University's plagiarism and good academic practice website ([www.cam.ac.uk/plagiarism](http://www.cam.ac.uk/plagiarism)) provides more information and guidance.

## **Student information on the use of Turnitin**

The University subscribes to Turnitin UK software which is widely used in UK universities and matches text in work submitted to the software to that in a large database of online sources. This document explains how Turnitin UK will be used by the Department of Engineering and explains the implications of submitting your work to the software.

You are reminded that Turnitin is only one method of checking the originality of your work. Examiners may initiate the standard investigative procedures if they have unresolved queries about the originality of your work, regardless of whether Turnitin has been used or whether it has substantiated any concerns.

The University Advocate may decide to prosecute a student suspected of plagiarism even where that student has not consented to the use of Turnitin. In such circumstances the student may be specifically asked by the Advocate to consent to submission to Turnitin and a failure to consent will be proved as part of the evidence against him or her.

### **Plagiarism and good academic practice: your responsibilities**

You should ensure that you are familiar with the [discipline-specific guidance](#) about referencing conventions and good academic practice which is issued by the Faculty Board. If, after reading this guidance, you have any outstanding queries, you should seek clarification at the earliest opportunity from your Director of Studies or supervisor.

You should also familiarise yourself with the statement on plagiarism posted on the University's plagiarism website, <https://www.plagiarism.admin.cam.ac.uk/> which also features links to useful resources and guidance.

If, after reading the guidance, you have any outstanding queries you should seek clarification at the earliest opportunity from your Director of Studies or supervisor.

## **About Turnitin UK text-matching software**

### *Who controls the service?*

Turnitin UK is part of the JISC Plagiarism Advisory Service (JISCPAS). This University is the recognised Data Controller for the data held and processed by, or on behalf of, the service. An American company, iParadigms, is the Data Processor.

### *How does Turnitin UK work?*

Turnitin UK may detect direct plagiarism, paraphrasing and collusion as submitted work is compared with a vast database of online material and with a 'private' database of previous submissions. Therefore, submitting work to the database helps to protect it from future attempts to plagiarise it, and helps to maintain the integrity of the University's qualifications.

The software makes no judgement about whether a student has plagiarised, it simply shows the percentage of the submission that matches other sources and produces an originality report which highlights the text matches and, where possible, displays the matching text and its immediate context.

In many cases the software highlights correctly cited references or 'innocent' matches. Therefore, Examiners will carefully review all originality reports to determine whether the work does contain plagiarism.

## **How will Turnitin UK be used in the Manufacturing and Management Division, Department of Engineering?**

Work submitted for assessment in the Manufacturing and Management Division, Department of Engineering will be subjected to spot checks from time to time, or in cases where there is cause for concern. Students should note that, upon screening work, the resulting originality reports will be referred only to the Examiners responsible for the academic assessment of the work if there is prima facie evidence of plagiarism or poor academic practice. Work must be submitted electronically.

## **What will happen if matches are identified between my work and another source?**

If Turnitin UK detects matches between your work and another source, the Examiners will review the resulting originality report to judge whether the matches are innocent, or whether you have appropriately referenced these matches (if not, this may constitute plagiarism), and/or whether you have made excessive use of material from other sources (which may be poor academic practice).

The Examiners will mark your work purely on the basis of its academic merit. However, depending on the extent and context of the matches, your work may be referred to the Proctors for further investigation. In such cases the Turnitin UK originality report may be used as evidence. If you are found to have plagiarised the penalty may be severe and your degree may be withheld.

## **Will Turnitin UK affect my intellectual property rights or copyright?**

The copyright and intellectual property rights of the submitted material remain wholly with the original owner (normally the student, with the exception of some collaborative or sponsored research projects). However, you are asked to permit Turnitin UK to:

- reproduce your work to assess it for originality;

- retain a copy of your work for comparison at a later date with future submissions.

### **Will my personal data be retained by Turnitin UK?**

Material submitted to Turnitin UK will be identified by your examination number, course details and institution: personal data will not be used.

### **What will happen if text submitted by another student matches that in my work?**

#### *Matches to text submitted from other HE institutions*

If a report generated by another institution identifies a match to your work the report will only show the extent of the match and the contact details of the University's Turnitin UK Administrator. If approached, the Turnitin UK Administrator will attempt to contact you about the matter. The contents of your work will not be revealed to a third party outside Cambridge without your permission.

#### *Matches to text submitted from within the University*

If a match is found to material submitted from within the University, the Examiners can obtain the full text without approaching you.

### **How do I apply for my work to be removed from Turnitin UK?**

Work submitted to Turnitin UK will be stored indefinitely on the Turnitin UK database unless you specifically request that it be removed. To maximise the effectiveness of the software it is hoped that such requests will be kept to a minimum. However, once examinations have been concluded, you may at any time contact [the Department's Turnitin UK contact] to request that your work be removed.

### **Sources of further information and support**

The University's plagiarism website: <https://www.plagiarism.admin.cam.ac.uk/>

Department's plagiarism advice: <http://teaching.eng.cam.ac.uk/node/526>

Turnitin UK's website: <http://www.turnitinuk.com/>



## **Appendix 2: Sample of MET IIA Forms**

<b>METIIA Coursework allowance application form</b>	<b>74</b>
<b>METIIA Industrial Visit allowance application form</b>	<b>75</b>

## METIIA Coursework allowance application form

Students must make every effort to contact staff in advance of the visit. E-mails should be copied to the MET office [met-admin@eng.cam.ac.uk](mailto:met-admin@eng.cam.ac.uk)

### Cambridge University Engineering Department Application for Allowance for Coursework / Missed Assessment

<b>Student Name:</b>	<b>College:</b>	<b>CRSID:</b>	<b>Tripos</b> (METIIA, METIIB)
----------------------	-----------------	---------------	--------------------------------

<b>Requesting an EXTENSION</b>						
Coursework title / METIIB Module	Staff member contacted for rescheduling	Date contacted	Reason for request	Current deadline	Requested deadline	Teaching Office response

<b>Requesting MARKS</b>						
Coursework title / METIIB Module	Staff member contacted for rescheduling	Date contacted	Reason for claim, e.g. Missed module assessment; late CW submission	Current mark	Requested mark	Teaching Office response

<b>Tutor's name:</b>	<b>e-mail:</b>	<b>Phone:</b>
----------------------	----------------	---------------

This section to be completed by the student's **TUTOR** (NOT DoS)

Nature of illness or extenuating circumstances:			
Dates between which work was <b>impossible</b>		Dates between which work was <b>hindered:</b>	
Additional comments (attach separate letter if you wish) <i>Please enclose doctor's certificate if period affected was more than 7 days</i>			
Signature of Tutor	Date	Signed (Teaching Office)	Date

*Return completed form to: IfM Teaching Office [met-admin@eng.cam.ac.uk](mailto:met-admin@eng.cam.ac.uk)  
Teaching Office decisions will be recorded on this form and a copy sent to the student and the Tutor*

## METIIA Industrial Visit allowance application form

Students must make every effort to contact staff in advance of the visit. E-mails should be copied to the MET office [met-admin@eng.cam.ac.uk](mailto:met-admin@eng.cam.ac.uk).

### Manufacturing Engineering Tripos Application for Allowance for industrial visits programme

<b>Student Name:</b>	<b>College:</b>	<b>CRSID:</b>
----------------------	-----------------	---------------

<b>Request for credit for missed visit</b>					
Visit date	Company	Staff member i/c visit	Date staff member contacted	Reason for missing visit	MET response

<b>Request for credit for missed debrief session</b>					
Debrief date				Reason for missing debrief session	MET response

<b>Tutor's name:</b>	e-mail:	Phone:
----------------------	---------	--------

*This section to be completed by the student's TUTOR (NOT DoS)*

Nature of illness or extenuating circumstances:			
Dates between which work was <b>impossible</b>		Dates between which work was <b>hindered</b> :	
Additional comments (attach separate letter if you wish) <i>Please enclose doctor's certificate if period affected was more than 7 days</i>			
Signature of Tutor	Date	Signed (METIIA Director or Visits Co-ordinator)	Date

**Return completed form to:** MET Teaching Office, IfM, 17 Charles Babbage Road [met-admin@eng.cam.ac.uk](mailto:met-admin@eng.cam.ac.uk)

Decisions will be made by the Visits Coordinator in consultation with METIIA Course Director. Responses will be recorded on this form and a copy sent to the student and the Tutor